

COM CAM

Energy Intelligence

User Manual

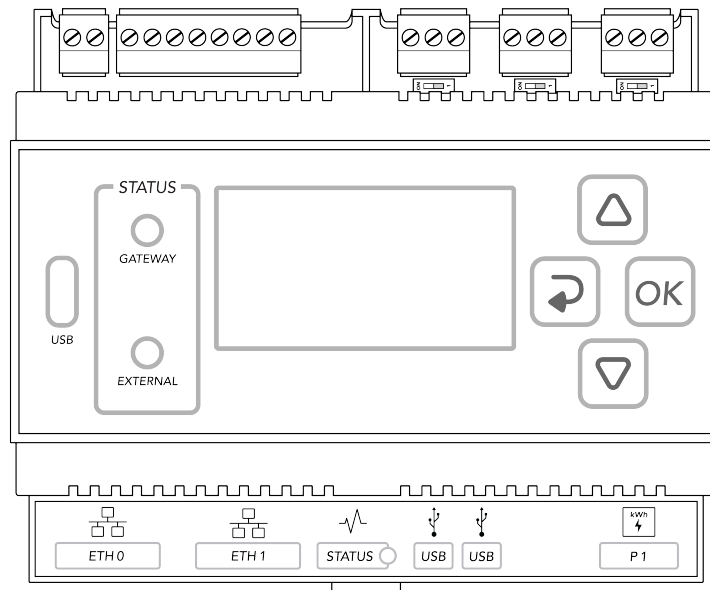

emb**ion**

Table of contents

COMCAM Stuurbox User Manual	8
Ownership rights	8
Copyright © Embion B.V. All rights reserved.	8
Disclaimer	8
Warranty for the COMCAM Stuurbox	10
1 About this document	11
1.1 Purpose	11
1.2 Intended Audience	11
1.3 Symbol conventions	12
1.4 Change history	13
2 Safety information	19
2.1 General Safety	19
2.1.1 Statement	19
2.1.2 General requirements	20
2.1.3 Personal safety	20
2.2 Personnel requirements	20
2.3 Electrical Safety	21
2.3.1 General	21
2.3.2 Product power supply	22
2.4 Installation environment requirements	22
2.5 Commissioning	22
2.6 Maintenance and replacement	22
3 Product overview	23
3.1 Model description	23
3.2 Model identification	23
3.3 Label appearance	23
3.4 Bulk label appearance	24
3.5 Product appearance	25
3.6 Communication ports	26
3.6.1 X10 RS485 Default inverter port	26
3.6.2 X11 RS485 Default meter port	27
3.6.3 X12 RS485 Default Auxiliaries port	28
3.6.4 X13 GPIO Port	29
3.6.5 X14 DC Input Port	30
3.6.6 ETH0 Port / POE	31
3.6.6.1 Port specifications	31

- 3.6.7 ETH1 Port 32
 - 3.6.7.1 Port specifications 32
- 3.6.8 USB0 Port 33
 - 3.6.8.1 Port specifications 33
- 3.6.9 USB1 Port 34
 - 3.6.9.1 Port specifications 34
- 3.6.10 P1 Port 34
 - 3.6.10.1 Port specifications 34
- 3.7 Status indicators 36
 - 3.7.1 Status LED 36
 - 3.7.2 Gateway LED 36
 - 3.7.3 External LED 36
- 3.8 Buttons 37
 - 3.8.1 UP Button 37
 - 3.8.2 DOWN Button 37
 - 3.8.3 BACK Button 38
 - 3.8.4 OK Button 38
- 3.9 Dimensions 38
- 3.10 Weight 39
- 4 Device installation 40**
 - 4.1 Box check 40
 - 4.1.1 Outer packaging 40
 - 4.1.2 Deliverables 40
 - 4.2 Required tools 41
 - 4.3 Installation Requirements 41
 - 4.4 Installing the COMCAM Stuurbox 43
 - 4.4.1 Wall-mounted installation 43
 - 4.4.2 DIN rail mounted 43
 - 4.4.2.1 Attach to DIN rail 44
 - 4.4.2.2 Remove from DIN rail 44
- 5 Device usage 45**
 - 5.1 Menu usage 45
 - 5.1.1 Menu overview 45
 - 5.1.2 Menu settings 45
 - 5.1.3 Menu pages 46
 - 5.1.4 Device information 46
 - 5.1.5 Config 46
 - 5.1.6 Updates 47
 - 5.1.7 System status 47
 - 5.1.8 Inverters 47
 - 5.1.9 Meters 48

5.1.10	P1 Smart meter	48
5.1.11	Modbus	49
5.1.12	Network ETH0	49
5.1.13	Network ETH1	49
5.1.14	Network Wi-Fi	50
5.1.15	GPIO	50
5.2	Input description	50
5.2.1	Input options	51
5.2.2	Select characters	51
5.2.3	Remove characters	51
5.2.4	Uppercase	52
6	Configuration settings	53
6.1	Apply settings	53
6.2	Activate config	54
6.2.1	Select strategy	54
6.2.1.1	Zonbalans	54
6.2.1.2	Arc detection	55
6.2.1.3	General	55
6.3	Inverter configuration	56
6.3.1	Inverter groups	56
6.3.2	Configure inverter group	57
6.3.2.1	Inverter connection	57
6.3.2.2	Inverter slave addresses	59
6.3.2.3	Inverter type	59
6.3.2.4	Inverter IP	61
6.3.2.5	Inverter TCP port	61
6.3.2.6	Strings/MPPT per inverter	63
6.3.2.7	Installed solar panels	63
6.3.2.8	Peak power per panel	63
6.3.2.9	Enable active power control	63
6.3.2.10	Maximum active battery power	64
6.3.2.11	Battery energy capacity	64
6.3.2.12	Set charge prio	64
6.3.2.13	Set discharge prio	64
6.3.2.14	Minimum SoC	64
6.3.2.15	Maximum SoC	65
6.3.2.16	Minimum SoC for remote control	65
6.3.2.17	Maximum SoC for non-solar charge	65
6.3.2.18	Allow automatic charge	65
6.4	Meter configuration	66
6.4.1	Meter groups	66

6.4.2	Configure meter group	68
6.4.2.1	Meter connection	68
6.4.2.2	Meter slave addresses	69
6.4.2.3	Meter type	69
6.4.2.4	Meter IP	71
6.4.2.5	Meter TCP port	71
6.4.2.6	Meter location	72
6.4.2.7	Split solar/grid	73
6.4.2.8	Override scaling factor (only for P1 meter)	73
6.4.2.9	Scale factor	74
6.5	EV Chargers	75
6.5.1	EV Charger groups	75
6.5.2	Configure EV Charger group	77
6.5.2.1	EV Charger type	77
6.5.2.2	EV Charger connection	77
6.5.2.3	Amount of chargers	78
6.5.2.4	EV Charger slave addresses	78
6.5.2.5	Min. charge current	79
6.5.2.6	Max. charge current	79
6.5.2.7	Set prio	79
6.5.2.8	EV Charger IP	80
6.5.2.9	Charger IP port	81
6.6	Auxiliaries	82
6.6.1	Auxiliaries groups	82
6.6.2	configure Auxiliaries group	83
6.6.2.1	Auxiliaries connection	83
6.6.2.2	Auxiliaries slave addresses	83
6.6.2.3	Auxiliaries type	84
6.6.2.4	Controllable load	84
6.6.2.5	Auxiliaries IP	84
6.6.2.6	Auxiliaries port	85
6.7	Grid settings	86
6.7.1	Grid settings configuration	86
6.7.1.1	Grid current max	86
6.7.1.2	Grid + power max	87
6.7.1.3	Grid - power max	87
6.8	Grid voltage control	88
6.9	Active power control	88
6.9.1	Safety margin	89
6.9.2	Low power limit	89
6.9.3	Total PV inverter power	90
6.9.4	Maximum power limit	90
6.9.4.1	Allow PV for import limit	91

6.9.4.2	Charge battery with grid return power	91
6.10	Arc detection	91
6.10.1	Arc detection configuration	91
6.10.1.1	Input type	91
6.10.2	Minimum PAC	93
6.10.3	Inverter address	93
6.10.3.1	Connecting the external arc detection	93
6.11	GPIO control	94
7	Device settings	96
7.1	ETH0 settings	96
7.1.1	ETH0 Setup	96
7.1.1.1	ETH0 Type	96
7.1.1.2	ETH0 IP Address	97
7.1.1.3	ETH0 Gateway IP address	97
7.1.1.4	ETH0 Netmask	97
7.1.1.5	ETH0 DNS	97
7.2	ETH1 settings	98
7.2.1	ETH1 Setup	98
7.2.1.1	ETH1 Type	98
7.2.1.2	ETH1 IP Address	99
7.2.1.3	ETH1 Gateway IP address	99
7.2.1.4	ETH1 Netmask	99
7.2.1.5	ETH1 DNS	100
7.3	Wi-Fi settings	100
7.3.1	Wi-Fi Setup	100
7.3.1.1	Wi-Fi Enable	100
7.3.1.2	Wi-Fi Network	101
7.3.1.3	Wi-Fi Password	101
7.4	Modbus settings	101
7.4.1	TCP configuration	102
7.4.1.1	Client / Server settings	102
7.4.1.2	Interface	102
7.4.1.3	TCP Port	103
7.4.1.4	Unit ID	103
7.4.2	RTU configuration	103
7.4.2.1	Baudrate	103
7.4.2.2	Parity	104
7.4.2.3	Databits	104
7.4.2.4	Stopbits	104
7.5	GPIO settings	106
7.5.1	Control GPO	106

7.6	System settings	107
7.6.1	Display setup (Dim brightness)	107
7.6.2	Display setup (Contrast settings)	107
7.6.3	Language selection	108
7.6.4	Factory Reset	108
7.7	Update settings	108
7.7.1	Check for updates	108
7.7.2	Install strategy	109
7.7.3	Notifications	109
7.7.4	Channel	109
7.8	Plant control	111
8	Appendix	112
8.1	Device specific instructions	112
8.1.1	Amtron 4you RTU configuration	112
8.1.2	ABL eM4 configuration	112
8.1.3	EVBox	112
8.1.3.1	EVBox G4	113

COMCAM Stuurbox User Manual

Ownership rights

This document is created and copyrighted by Embion B.V.

COMCAM Energy Intelligence is granted permission to use this document, but is prohibited from editing or modifying its content. This permission is subject to compliance with applicable laws and regulations.

Copyright © Embion B.V. All rights reserved.

No part of this document may be reproduced, stored in a retrieval system, or transmitted in any form or by any means, electronic, mechanical, photocopying, recording, or otherwise, without the prior written permission of Embion B.V. The information contained in this document is subject to change without notice. Embion B.V. makes no warranty of any kind with respect to this information, including but not limited to the implied warranties of merchantability and fitness for a particular purpose. Embion B.V. shall not be liable for errors contained herein or for incidental or consequential damages in connection with the furnishing, performance, or use of this material.

Disclaimer

By using this product, the user acknowledges and accepts this disclaimer.

The COMCAM Stuurbox is designed for use in electrical systems, but it is not a safety device. It is the responsibility of the user to ensure that the system is properly equipped with the necessary safety measures to protect against any potential hazards. If the user is unsure about the safety requirements of their electrical system, they should consult with a qualified installer or distributor to determine what additional components or redundancy measures may be necessary. Embion B.V. cannot be held liable for any damages or injuries resulting from the use of the COMCAM Stuurbox without proper safety measures in place.

Exclusions/Limitations of Liability

1. In case of attributable non-performance, Embion is obliged to still fulfill its contractual obligations. Any liability of Embion is limited to what is regulated in this provision.
2. The potential liability of Embion, based on any legal ground whatsoever, cannot result in it having to pay an amount to its customer that exceeds the amount paid out in any given case under an insurance policy concluded by Embion.

3. If, for whatever reason, Embion is unable to invoke clause 2 of this article, the obligation to pay any amount, for whatever reason, is limited to a maximum of the purchase price (exclusive of VAT), plus 15%. If the agreement between Embion and its customer consists of parts or partial deliveries, this obligation is limited to the purchase price of that part or partial delivery (exclusive of VAT), plus 15%.
4. The potential obligation of Embion to compensate for damage is furthermore limited to what is regulated hereinafter in this provision.
5. Embion can only be liable for direct damage. Liability for indirect damage and for disadvantage that does not consist of pecuniary loss is explicitly excluded.
6. Direct damage solely refers to the reasonable costs incurred in determining the cause and extent of the damage, insofar as the determination concerns damage within the meaning of these terms, any reasonable costs incurred to make the product supplied by Embion comply with the agreement, insofar as these can be attributed to Embion, and reasonable costs incurred to prevent or limit direct damage as referred to in these general terms and conditions.
7. Indirect damage includes, but is not limited to: consequential damages, loss of (production) profit, energy costs, feed-in costs, network costs or fees, missed net metering, missed savings, lost profits, fines, taxes, levies, missed tax benefits, and missed subsidies.
8. The total liability of Embion is limited to what is determined above.
9. The customer indemnifies Embion against claims from third parties, on any grounds whatsoever, who suffer damage in connection with the performance of the agreement between Embion and its customer and where the cause is attributable to anyone other than Embion.

Warranty for the COMCAM Stuurbox

Embion B.V. provides a limited warranty for the COMCAM Stuurbox (the "Product") to the original purchaser ("Purchaser") for a period of two (2) years from the date of purchase.

Embion B.V. warrants that the Product will be free from defects in materials and workmanship under normal use and service. If any defects in the Product occur during the warranty period, Embion B.V. will, at its sole option and cost, either repair or replace the defective Product or refund the purchase price paid by the Purchaser.

This warranty does not cover any damage caused by misuse, abuse, accident, neglect, or unauthorized modification of the Product. The warranty also does not cover any damage caused by natural disasters.

To make a warranty claim, the Purchaser must provide proof of purchase and contact the reseller of the COMCAM Stuurbox. The reseller will provide instructions on how to return the defective Product and receive a replacement or refund.

THIS WARRANTY IS THE ONLY EXPRESS WARRANTY MADE BY Embion B.V. WITH RESPECT TO THE PRODUCT. Embion B.V. EXPRESSLY DISCLAIMS ALL OTHER WARRANTIES, INCLUDING BUT NOT LIMITED TO IMPLIED WARRANTIES OF MERCHANTABILITY AND FITNESS FOR A PARTICULAR PURPOSE. IN NO EVENT SHALL Embion B.V. BE LIABLE FOR ANY INCIDENTAL, SPECIAL, OR CONSEQUENTIAL DAMAGES ARISING OUT OF OR IN CONNECTION WITH THE PRODUCT OR THIS WARRANTY.

Some jurisdictions do not allow limitations on how long an implied warranty lasts or the exclusion or limitation of incidental or consequential damages, so the above limitations may not apply to the Purchaser. This warranty gives the Purchaser specific legal rights, and the Purchaser may also have other rights which vary from jurisdiction to jurisdiction.

This warranty is governed by and shall be construed in accordance with the laws of the Netherlands without giving effect to any choice of law or conflict of law provisions. Any dispute arising out of or in connection with this warranty shall be resolved by the courts of the Netherlands.

1 About this document

1.1 Purpose

This document introduces the COMCAM Stuurbox in terms of installation, electrical connections, system operation and maintenance and troubleshooting. Understand the COMCAM Stuurbox features, functions and safety precautions provided in this document before installing and operating the COMCAM Stuurbox.

To ensure an identical menu layout, please make sure that the version number of this document corresponds to the software release of the COMCAM Stuurbox.

1.2 Intended Audience

This document is intended for operating personnel, system engineers adopting the COMCAM Stuurbox in their system design.

1.3 Symbol conventions

The symbols that may be found in this document are defined as follows:

 Note

Used for general notes in this documentation

 Warning

Used for expressing warnings in this documentation

 Important

Used for important notes in this documentation

 Tip

Used for general tips in this documentation

 Caution

Used for caution notes in this documentation

1.4 Change history

V4.3.3

Improvements:

- Fix Modbus server register offsets & reconnect-ability
- Improved PV control

02/18/2025

V4.3.2

Improvements:

- Correction for Cubenergy PowerCombo
- Allow multiple TCP ports for single IP and unit id

02/11/2025

V4.3.1

Improvements:

- Correct empty menu

02/07/2025

V4.3.0

New features:

- Added support for Sigenergy (no PV control, no total PV yield)
- Added support for Cubenergy PowerCombo

Improvements:

- Improved handling for offline devices
- Fix in Modbus server Holding Registers
- Fix for invalid values SMA datalogger

02/07/2025

V4.2.0

New features:

- Added Modbus TCP server functionality
- Added support for FOX-ESS GMax
- Added support for Weiheng V2
- Added support for EVBox G4
- Added support to control Ctek charger (Firmware version r4.9 or newer)
- Added support for Kempower DC charger (no total charged energy)

Improvements:

- Correction for SolaX 3PH inverter
- Correction for Sungrow yield readout
- Name change Myrtillo to eCactus TH Hybrid

02/04/2025

V4.1.0

New features:

- Added support for SolaX X3 Ultra
- Added support for Studer Next3
- Added support for Myrtillo battery (No Solar control)
- Added controllable load as Auxiliary device
- Added support for Schneider EVLink Pro AC (Software version 1.2.1 and newer)

Improvements:

- Improved battery power controller

01/08/2025

V4.0.0

New features:

- Added auto correction on negative grid settings
- Added mloea tap function
- Added support for solar meter
- Added update configuration settings using HUB
- Added support feature through HUB
- Added Wi-Fi signal strength to HUB

Improvements:

- Adjusted Wi-Fi network list order
- Updated welcome screen for new installations

12/12/2024

V3.6.1

Improvements:

- Solved issue where some inverters did not upload its yield data
- Modbus stability improved

11/12/2024

V3.6.0

New features:

- Wi-Fi functionality
- Support for ALP-EV, Vestel and Amtron EV chargers
- Support for Siemens PAC2200 7km and Schneider PM8000 series energy meter
- Support for Chint solar inverters
- Support for Cellpower battery system
- Improved daily yield calculations
- Automatic license activation

Improvements:

- Improve Huawei Hybrid communication for multiple inverters

11/20/2024

V3.5.1 - Fix bug: inverters where not correctly configured. 10/28/2024

V3.5.0 - Optimization of EV charger control, exceptional issue with MLOEA configurations resolved, Add voltage readings for EV chargers. Improved upload of device data. Add Sofar Power Magic battery. Improve battery control. Add factory reset option. 10/16/2024

V3.4.0 - Add Victron battery system, add Autarco solar inverter, add ABL eM4 ev charger, add Phoenix EEM energy meter, improve Modbus stability. 8/21/2024

V3.3.1 - Fix total EV charger power calculation for Orbis chargers. Fix GPIO control when single is selected, while fields are not filled. 8/6/2024

V3.3.0 - Add support for Solax Trene battery and GoodWe-HT inverters, add support for Ctek ev charge (no power control). Automatically charge battery when SoC drops below minimum SoC. Add optional controller for PV release for import limit during min-generation. Add support for GPIO control on summed load meters, battery power and PRIO. Fix problem for controlling multiple batteries. 8/2/2024

V3.2.1 - Improve (weighted) SoC and summed (plant) battery power calculation. 7/16/2024

V3.2.0 - Allow "group control" for GPIO on external modules. Allow same Unit IDs on multiple TCP devices. Upload plant battery power and SoC and EV charger power. Add Fronius inverter, Deye HV battery inverter. Schneider IEM 3 phase and Inepro PRO380 energy meter added and correct IME Nemo EC readout. Fix Alfen energy readout. General improvements. 7/15/2024

V3.1.2 - Fix issue with Solax inverters, fix powerfactor scaling for IME NEMO energy meter. 6/18/2024

V3.1.1 - Fix issue with Huawei Bess and OX power battery 6/6/2024

V3.1.0 - Add Weiheng battery, fix Deye maximum strings, change device list to alfabatic order. 5/29/2024

V3.0.0 - Internal system architecture upgrade. Add OX Energy B-OX XL battery system, add IME Nemo EC energy meter. Allow configurable scale factor for P1 energy meter. 5/17/2024

V2.14.2 - Fix gridpower upload to HUB portal. 4/18/2024

V2.14.1 - Improve counter strategy, fix enable reduction problem for Sungrow inverters. 4/16/2024

V2.14.0 - Add Huawei Hybrid inverter, GoodWe Hybrid and Maxus battery. Add Diris B10 and IME Conto energy meter. Fix scaling for ABB B23/B24. 4/8/2024

V2.13.0 - Add Huawei SL BESS system, make difference for Chint DTSU666 (series and normal). Add support for Ratio EV charger. Add Afore HV for HV battery systems. Add Safety margin option for active power control. 3/8/2024

V2.12.0 - Add battery SoC control. Fix error messages. Fix Schneider IEM 1 phase energy meter exported energy readout. General bugfixes. 2/13/2024

V2.11.0 - Add support for GoodWe and GoodWe-MT inverter, fix large AC power values for ABB PVS during the night. 1/24/2024

V2.10.0 - Add support for Megarevo hybrid inverter, Sungrow inverter and Schneider IEM 1 phase energy meter. Further improve battery control. Allow control for 1 phase grid connections. Fix minor bugs. 1/19/2024

V2.9.0 - Add support for battery control. Add support for Solis hybrid, Boltainer battery, Pixii battery, Ferroamp and Afore hybrid. Add support for IME Nemo, Mbus gateway and CarloGavazzi energy meters. Fix scaling with Janitza energy meter. 1/2/2024

V2.8.1 - General bugfixes and stability improvements. 12/12/2023

V2.8.0 - Add support for Zeversolar and Solis inverters, rebrand counteracting to Zonbalans with new spec. Add specific error messages for strategy. Allow autonomous update from selected track. 12/1/2023

V2.7.1 - Network static fix, ABB M4M IL2 fix 11/3/2023

V2.7.0 - Add support for Sneider 7KT, Huawei SL meter and ABB M4M energy meters. 11/2/2023

V2.6.1 - Fix EV charge control without inverters, Fix Eastron power factor readout. 10/27/2023

V2.6.0 - Add support for Altilia, Eaton Xstorage, Deye and Sofar G3 Hybrid inverters and Chint DTSU666 energy meter. Fix TCP IP configuration. 09/29/2023

V2.5.0 - Add ABB PVS inverter. Bugfix for GPO configuration in general template. 09/20/2023

V2.4.0 - New limits for counteracting strategy. Allow prio select for controlled loads. Enable data compression on the portal connection to significantly reduce the required internet data. Minor changes and bug fixes. 09/11/2023

V2.3.0 - Add "low power limit" control for generic strategy. Improve Counteracting strategy with requirements Enexis. Add support for EV chargers. Minor changes. 08/15/2023

V2.2.1 - Add gridvoltage control, active power control and GPIO control. Update supported inverter list and ETH0 and ETH1 settings. Minor changes. 07/21/2023

V2.1.0 - Update disclaimer, add IP range configuration for inverter, meter EV charger and auxiliaries, add split solar and grid option for load meters, add MLOEA configuration for grid meter and add system language configuration. Added warranty information. 04/11/2023

V2.0.0 - First release of the user manual 03/10/2023

2 Safety information

2.1 General Safety

2.1.1 Statement

Before installing, operating or maintaining the equipment, read this document and observe all safety instructions on the equipment and in this document.

The “Warning”, and “Caution” statements in this document do not cover all the safety instructions. They are only supplements to the safety instructions. Embion B.V. will not be liable for any consequence caused by the violation of general safety requirements.

Ensure that the equipment is used in environments that meet its design specifications. Otherwise, the equipment may become faulty, the resulting equipment malfunction, component damage, personal injuries, or property damage are not covered under the product warranty.

Follow local laws and regulations when installing, operating, or maintaining the equipment. The safety instructions in this document are only supplements to local laws and regulations.

Embion B.V. will not be liable for any consequences of the following circumstances:

- Operation beyond the conditions specified in this document
- Installation or use in environments which are not specified in relevant international or national standards
- Unauthorized modifications to the product, software or removal of the product warranty sticker
- Failure to follow the operation instructions and safety precautions on the product and in this document
- Equipment damage due to force majeure, such as earthquakes, fire, and storms
- Damage caused during transportation by the customer
- Storage conditions that do not meet the requirements specified in this document

2.1.2 General requirements

 Warning

Do not work with system power turned-on during installation

- After installing the equipment, remove idle packing materials such as cartons, foam, plastics, and cable ties from the equipment area
- In the case of a fire, immediately leave the building or the equipment area, and turn on the fire alarm bell or make an emergency call. Do not enter the building on fire in any case
- Do not scrawl, damage, or block any warning label on the equipment
- Tighten the screws using the correct tools when installing the equipment
- Understand the components and functioning of the system, the COMCAM Stuurbox and relevant local standards
- You shall not to reverse engineer, decompile, disassemble, adapt, add code to, or alter in any other way, the device software; research the internal implementation of the device; obtain the device software source code; infringe on Embion B.V.'s intellectual property; or disclose any performance test results related to the device software.

2.1.3 Personal safety

- If there is a probability of personal injury or equipment damage during operations on the equipment, immediately stop the operations, report the case to the supervisor, and take feasible protective measures.
- Use tools correctly to avoid hurting people or damaging the equipment

2.2 Personnel requirements

- Personnel who plan to install or maintain Embion B.V. equipment must receive thorough training, understand all necessary safety precautions, and be able to correctly perform all operations
- Personnel working with the COMCAM Stuurbox must have knowledge of IP-based networks, RS485 bus systems, Modbus and addressing, validation of energy measurements, and knowledge of the devices to which the COMCAM Stuurbox is connected. The exact required knowledge may vary depending on the installation and application

- Only qualified professionals or trained personnel are allowed to install, operate, and maintain the equipment
- Only qualified professionals are allowed to remove or acknowledge any safety lock or notification on the device
- Only professionals or authorized personnel are allowed to replace the equipment or components

i Note

- Professionals: personnel who are trained or experienced in equipment operations and are clear of the sources and degree of various potential hazards in equipment installation, operation, and maintenance. It is task of a professional to understand the working concept of the complete system. This is required to correctly configure the COMCAM Stuurbox
- Trained personnel: personnel who are technically trained, have required experience, are aware of possible hazards on themselves in certain operations, and are able to take protective measures to minimize the hazards on themselves and other people
- Operators: operation personnel who may come in contact with the equipment, except trained personnel and professionals

2.3 Electrical Safety

2.3.1 General

⚠ Warning

Before connecting cables, ensure that the equipment is intact. Otherwise, electric shocks or fire may occur.

- Ensure that all electrical connections comply with local electrical standards.
- Ensure that the cables you prepared meet local regulations.

2.3.2 Product power supply

⚠ Warning

Do not connect or disconnect power cables with power on.

- Before making electrical connections, switch off the disconnecter on the upstream,
- Before connecting a power cable, check that the label on the power cable is correct.
- If the equipment has multiple energized inputs, disconnect all the energized inputs before operating the equipment.

2.4 Installation environment requirements

- Ensure that the equipment is installed in a well ventilated environment.
- Ensure the environment temperature does not exceed the maximum allowed environment temperature.
- Do not expose the equipment to flammable or explosive gas or smoke. Do not perform any operation on the equipment in such environments.

2.5 Commissioning

When the equipment is powered on for the first time, ensure that professional personnel set parameters correctly. Incorrect settings may result in damage to subsystems connected to the COMCAM Stuurbox.

2.6 Maintenance and replacement

- Maintain the equipment with sufficient knowledge of this document and using proper tools and testing equipment.
- If the equipment is faulty, contact your dealer.
- The equipment can be powered on only after all faults are rectified. Failing to do so may escalate faults or damage the equipment.

3 Product overview

3.1 Model description

This document covers the following COMCAM Stuurbox models:

- GSE-A010
- GSE-A010-POE

3.2 Model identification

The model number of the COMCAM Stuurbox can be found on the label on the side of the device. The model number is listed on the label under PN (Product Name).

3.3 Label appearance

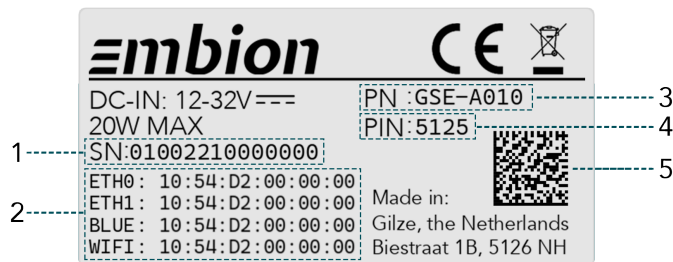

1. Serial Number
2. MAC Addresses
3. Product Name
4. PIN Code
5. Datamatrix

3.4 Bulk label appearance

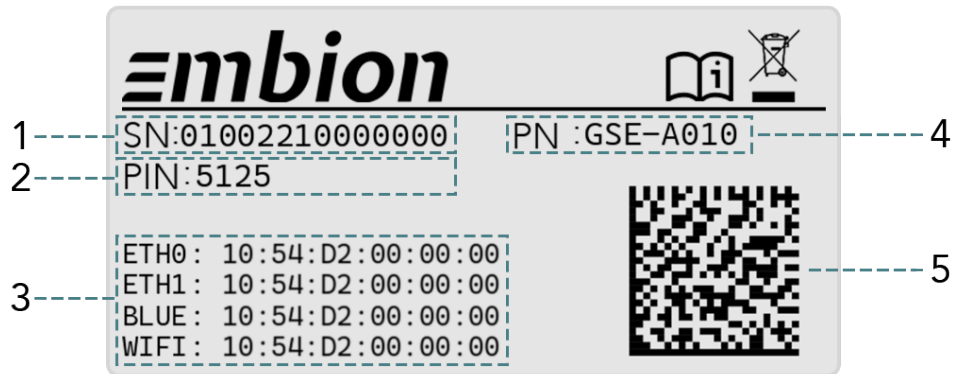

1. Serial Number
2. PIN Code
3. MAC Addresses
4. Product Name
5. Datamatrix

3.5 Product appearance

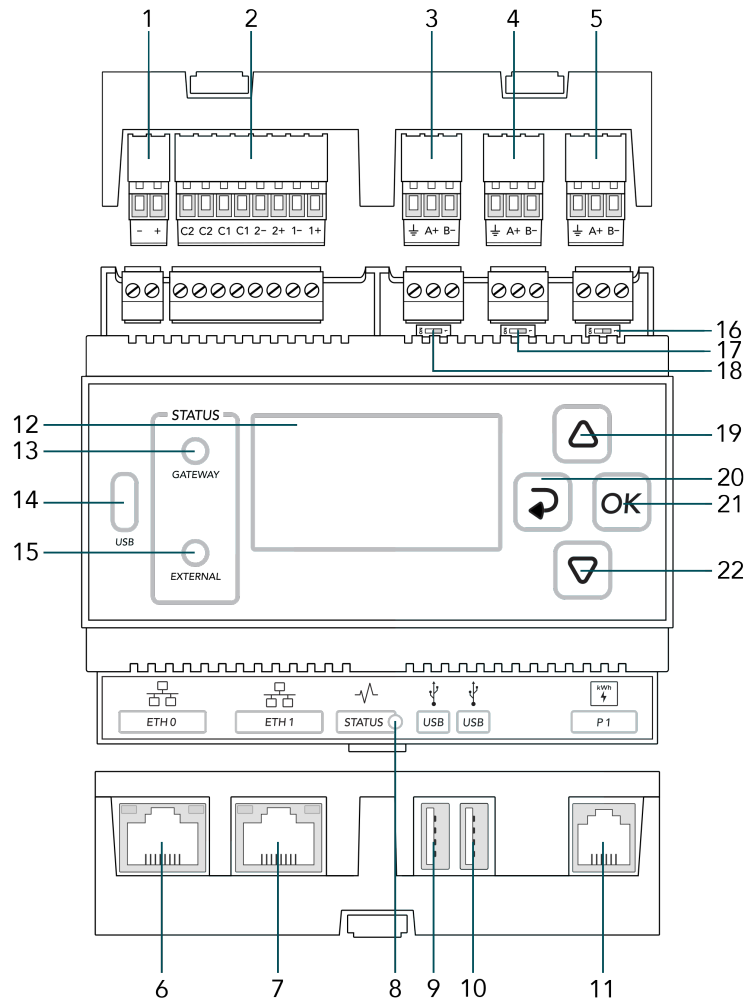

- | | | |
|----------------------|----------------------------|----------------------------|
| 1. X14 DC Input Port | 9. USB Port 0 | 17. X11 termination switch |
| 2. X13 GPIO Port | 10. USB Port 1 | 18. X12 termination switch |
| 3. X12 RS485 Port C | 11. P1 Port | 19. Arrow up button |
| 4. X11 RS485 Port B | 12. LCD Screen | 20. Back button |
| 5. X10 RS485 Port A | 13. Gateway status LED | 21. OK button |
| 6. ETH Port 0 / POE | 14. USB-C Port | 22. Arrow down button |
| 7. ETH Port 1 | 15. Service status LED | |
| 8. Status LED | 16. X10 termination switch | |

3.6 Communication ports

3.6.1 X10 RS485 Default inverter port

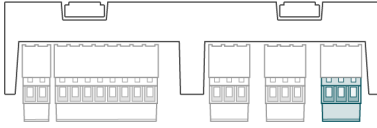

The X10 RS485 connector is the default inverter port. It is possible to deviate from the default and use the port for something else as inverters.

X10 RS485 Connector			
Appearance	Pin Name		Description
	1	B-	RS485 Negative signal
	2	A+	RS485 Positive signal
	3	⊥	RS485 SHIELD (ISOGND)

X10 120 ohm termination switch	
Position	Description
	Termination ON
	Termination OFF

The X10 120 ohm termination switch is used to terminate the the X10 RS485 bus.

! Important

The protocol and port settings (baudrate, parity databits and stopbits) need to be identical for all devices connected to the X10 port. Every (Modbus) slave address should be unique per port.

3.6.2 X11 RS485 Default meter port

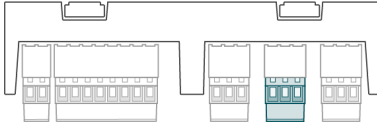

The X11 RS485 connector is the default meter port. It is possible to deviate from the default and use the port for something else as meters.

X11 RS485 Connector		
Appearance	Pin Name	Description
	1 B-	RS485 Negative signal
	2 A+	RS485 Positive signal
	3 \perp	RS485 SHIELD (ISOGND)

X11 120 ohm termination switch	
Position	Description
	Termination ON
	Termination OFF

The X11 120 ohm termination switch is used to terminate the the X11 port.

! Important

The protocol and port settings (baudrate, parity databits and stopbits) need to be identical for all devices connected to the X11 port. Every (Modbus) slave address should be unique per port.

3.6.3 X12 RS485 Default Auxiliaries port

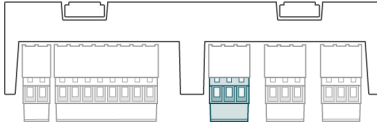

The X12 RS485 connector is the default auxiliary devices port. It is possible to deviate from the default and use the port for something else as auxiliary devices.

X12 RS485 Connector		
Appearance	Pin Name	Description
	1 B-	RS485 Negative signal
	2 A+	RS485 Positive signal
	3 \perp	RS485 SHIELD (ISO GND)

X12 120 ohm termination switch	
Position	Description
	Termination ON
	Termination OFF

The X12 120 ohm termination switch is used to terminate the the X12 port.

! Important

The protocol and port settings (baudrate, parity databits and stopbits) need to be identical for all devices connected to the X12 port. Every (Modbus) slave address should be unique per port.

3.6.4 X13 GPIO Port





The X13 GPIO connector can be used for general input/output control.

X13 GPIO Port		
Appearance	Pin Name	Description
	1 1+	Potential free input #1 (+)
	2 1-	Potential free input #1 (-)
	3 2+	Potential free input #2 (+)
	4 2-	Potential free input #2 (-)
	5 C1	Potential free output contact #1
	6 C1	Potential free output contact #1
	7 C2	Potential free output contact #2
	8 C2	Potential free output contact #2

GPIO electrical specifications			
Item	Min	Max	Unit
Input 'low' voltage	-32.0	2.0	V
Input 'high' voltage	5.0	32.0	V
Input forward current	1.0	6.0	mA
Contact (C) switch voltage	-	32.0	V
Contact (C) switch current	-	2.0	A
GPIO isolation voltage	-	48.0	V

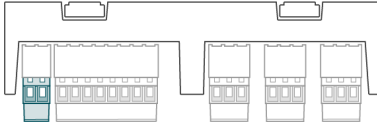
3.6.5 X14 DC Input Port



X14 DC Port			
Appear	Pin	Name	Description
	1	+	External DC power supply (+)
	2	-	External DC power supply (-)

DC input supply specifications			
Item	Min	Max	Unit
DC input voltage	12.0	32.0	V
DC input current	-	2.0	A
DC input power	-	20.0	W

3.6.6 ETH0 Port / POE

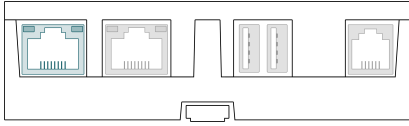

The ETH0 port can be used as normal Ethernet port and for powering the COMCAM Sturbox with Power over Ethernet (POE) (only for the POE variants).

3.6.6.1 Port specifications

- 10/100/1000 Mbps

For the POE variant (PN: GSE-A010-POE):

- IEEE 802.3af PoE support (not recommended due to the power limit), device may reduce performance
- IEEE 802.3at PoE+ support
- Redundant power source possible, automatically switches between PoE and DC input. If both are present, PoE is preferred.

ETH0 Pinning	
Appearance	Pin Description
	1 BI_DA+
	2 BI_DA-
	3 BI_DB+
	4 BI_DC+
	5 BI_DC-
	6 BI_DB-
	7 BI_DD+
	8 BI_DD-

ETH0 Indicators	
Indicator	Description
Green	Blinks when data is transmitted/received
Yellow	On when POE+ source is connected

3.6.7 ETH1 Port

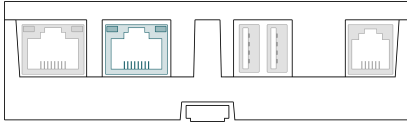

The ETH1 port can be used for ethernet connections on the COMCAM Stuurbox

3.6.7.1 Port specifications

- 10/100 Mbps

ETH1 Pinning	
Appearance	Pin Description
	1 TX+
	2 TX-
	3 RX+
	4 NC
	5 NC
	6 RX-
	7 NC
	8 NC

ETH1 Indicators	
Indicator	Description
Green	Blinks when data is transmitted/received
Yellow	Reserved

3.6.8 USB0 Port

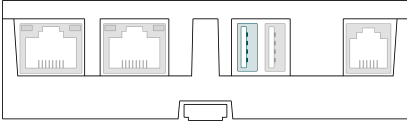

The USB0 port can be used to insert external storage devices into the COMCAM Stuurbox.

3.6.8.1 Port specifications

- Up to 500mA current delivery

USB0 Pinning		
Appearance	Pin	Description
	1	+5V
	2	D-
	3	D+
	4	GND

3.6.9 USB1 Port

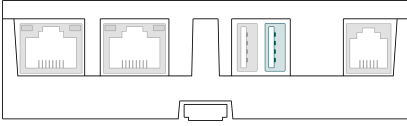

The USB1 port can be used to insert external storage devices into the COMCAM Stuurbox.

3.6.9.1 Port specifications

- Up to 500mA current delivery

USB1 Pinning		
Appearance	Pin	Description
	1	+5V
	2	D-
	3	D+
	4	GND

3.6.10 P1 Port

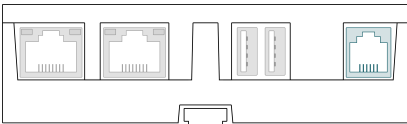

The P1 port is used to directly connect to a compatible smart meter.

3.6.10.1 Port specifications

- Reads meter directly from P1 connection on smart meter
- Support for DSMR 4.0-5.0
- Fixed baudrate of 115200 Baud
- Only usable for unencrypted meter data

⚠ Warning

Please make sure the meter connected to P1 is a DSMR 4 or DSMR 5 meter. Older DSMR versions are not supported at the moment.

P1 Pinning	
Appearance	Pin Description
	1 NC
	2 Data request
	3 ISOGND
	4 NC
	5 Data
	6 ISOGND

3.7 Status indicators

3.7.1 Status LED

Status LED		
LED	LED Status	Description
	Green	Device operational
	Red	System busy
	Blue	Reserved

3.7.2 Gateway LED

Gateway LED		
LED	LED Status	Description
	Green	Services are running
	Yellow	Problem with a service
	Red	Not operating

3.7.3 External LED

External LED		
LED	LED Status	Description
	Green	Reserved
	Yellow	Reserved
	Purple	Remote support enabled
	Blue	External plant control active

3.8 Buttons

3.8.1 UP Button

Button UP		
Appearance	Press	Action
	Short press	Short press action
	Long press	Long press action

3.8.2 DOWN Button

Button DOWN		
Appearance	Press	Action
	Short press	Short press action
	Long press	Long press action

3.8.3 BACK Button

Button BACK		
Appearance	Press	Action
	Short press	Short press action
	Long press	Long press action

3.8.4 OK Button

Button OK		
Appearance	Press	Action
	Short press	Short press action
	Long press	Long press action

3.9 Dimensions

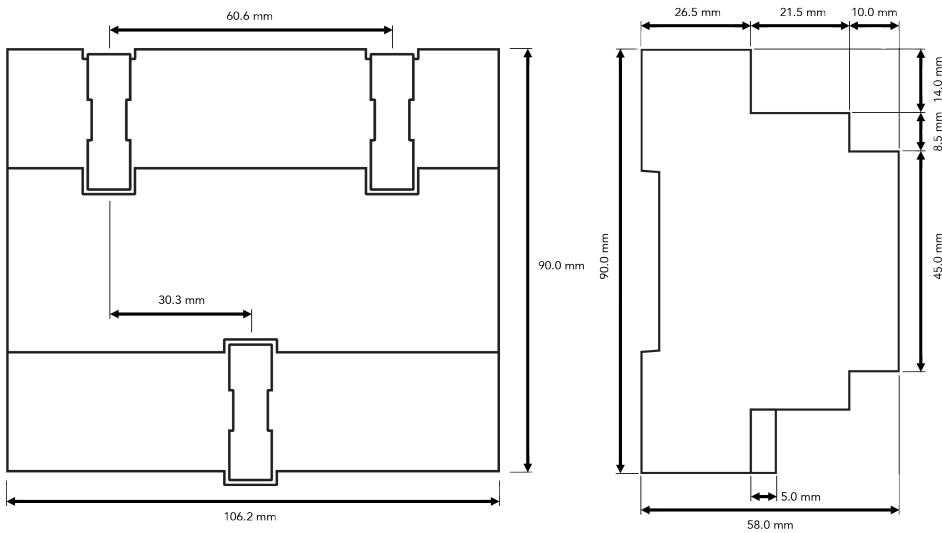

3.10 Weight

PN	Weight	Unit
GSE-A010	335	gram
GSE-A010-POE	355	gram

4 Device installation

4.1 Box check

4.1.1 Outer packaging

Check if outer packaging is undamaged before opening it. If there are any signs of damage or abnormality, do not open the package and contact your dealer immediately.

4.1.2 Deliverables

Check if the quantity against packing list is in the packing case. If any component is missing or damaged, contact your dealer.

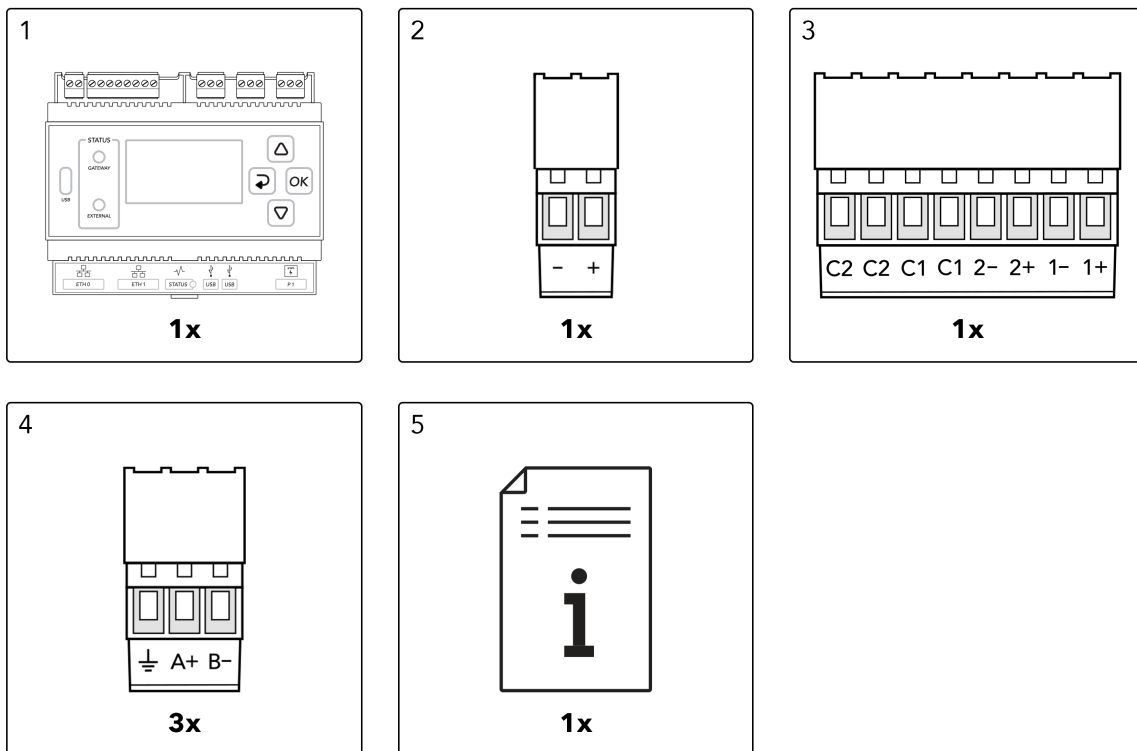

i Note

All provided connectors are already plugged into the device

4.2 Required tools

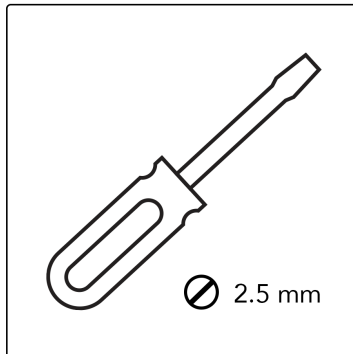
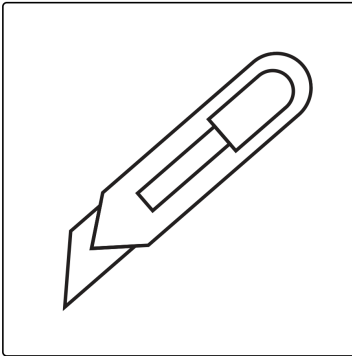

i Note

Depending on the specific type of installation and type of environment, extra tools may be required.

4.3 Installation Requirements

i Note

Proper installation of the COMCAM Stuurbox is essential for achieving optimum performance and ensuring easy maintenance. It is crucial to adhere to the recommended height to ensure optimal functionality. Additionally, it is important to meet the minimum object distance, ambient temperature, and humidity requirements to maintain the validity of the warranty. Failure to comply with these guidelines may result in voiding the warranty.

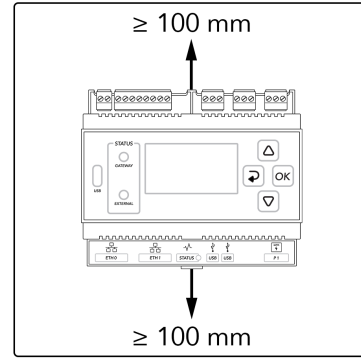
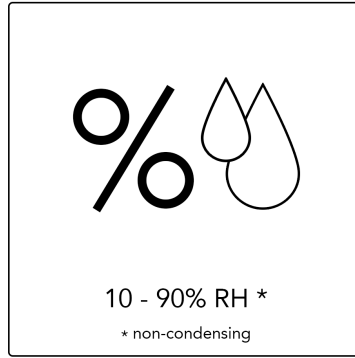
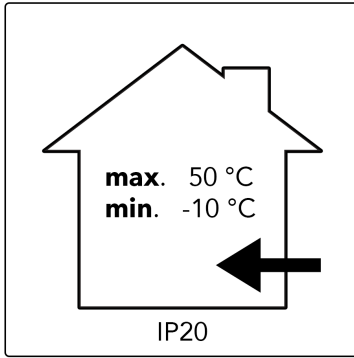

4.4 Installing the COMCAM Stuurbox

The COMCAM Stuurbox can be wall-mounted or DIN rail-mounted (preferred).

4.4.1 Wall-mounted installation

Warning

The COMCAM Stuurbox should be installed at a proper height to facilitate operation and maintenance

Install the COMCAM Stuurbox on a flat and secure wall

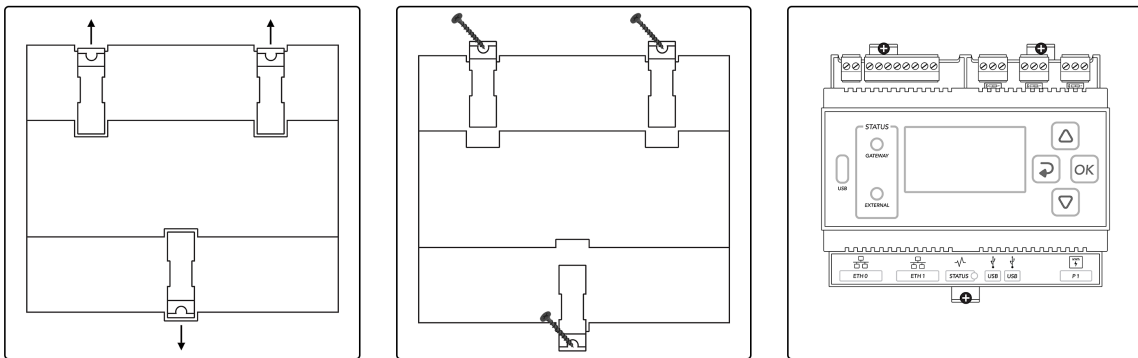

4.4.2 DIN rail mounted

Prepare a 35mm standard DIN rail (not included). Ensure that the rail:

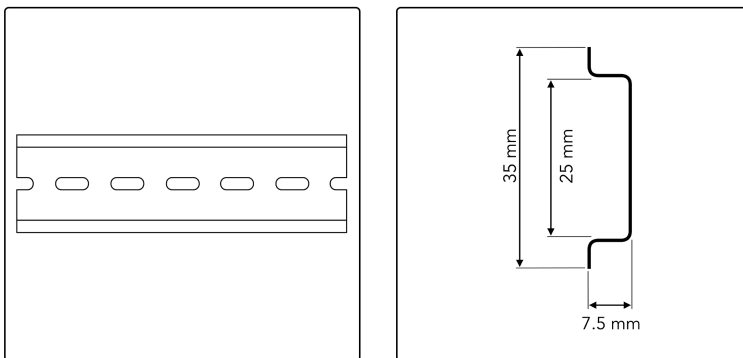

Ensure that the rail:

- Has sufficient length for securing the COMCAM Stuurbox. The recommended effective length is 120 mm or greater.
- Has been secured before you install the COMCAM Stuurbox.
- Is correctly terminated, so the COMCAM Stuurbox can't slide.

4.4.2.1 Attach to DIN rail

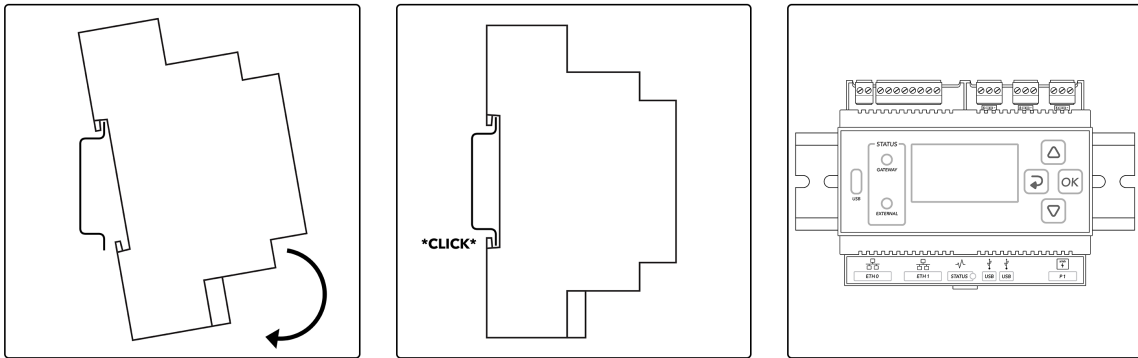

4.4.2.2 Remove from DIN rail

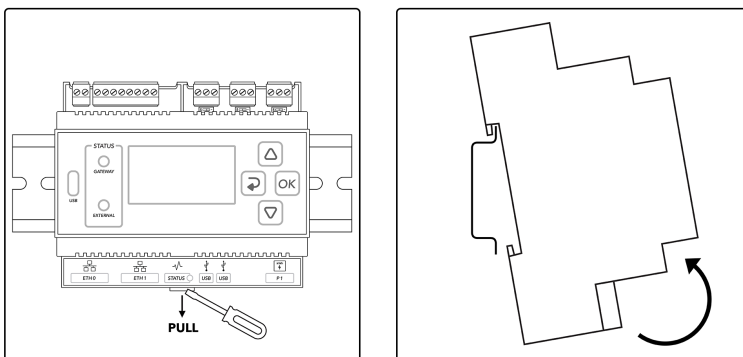

5 Device usage

5.1 Menu usage

The COMCAM Stuurbox device menu is used to configure the device. Multiple inputs are required during these settings. To allow for a standard and generic input option a dedicated input menu is designed. This menu allows for free character input, but it is important to understand the way of working as described in this chapter.

Tip

The COMCAM Stuurbox also supports remote configuration via the HUB portal when the device is connected to the internet. After adding the device to a namespace, the user is able to setup the device through the HUB web interface.

5.1.1 Menu overview

The main page that is shown contains some general information about the installation. This page will automatically be shown when there is no more interaction between user and device. The items shown on this page may vary depending on the configuration. The dark bar shows actual system information.

```
Solar pwr : --kW  
Solar yld : --kWh  
Grid power: --kW
```



5.1.2 Menu settings

When a menu page contains an arrow in the right corner, it means that there is a settings menu for it. Press the OK button to open the settings for the selected menu page. The images below show an example of the menu page "Modbus" which contains a settings menu "Modbus settings".

Modbus	
RTU A	: --
RTU B	: --
RTU C	:Idle
TCP	:Idle

Modbus settings	
●	Setup TCP
	Setup RTU-A (X10)
	Setup RTU-B (X11)
	Setup RTU-C (X12)

5.1.3 Menu pages

An overview of all the COMCAM Stuurbox menu pages with the related settings menu page is shown below. When a settings page is present, a reference to the related information page is given.

5.1.4 Device information

Device info	
SN	:0100223301000P
PN	:GSE-A010
PIN	:5127
SFTWW	:
PRODW	:1.0.1

Device info	
MFGDT	:20082022

This page shows product information which is identical to the information on the product label. Also current software version is visible in this menu. Also the minimum and maximum internal measured temperatures (during lifetime) are shown here.

5.1.5 Config

This page will show the active strategy. For example: General. By entering the menu, strategy settings can be changed.

Config	
Strategy	:General

Config settings	
●	Apply settings
	Inverters
	Meters
	EV Chargers
	Auxiliaries

More information about the config settings can be found here: [Section 6](#)

5.1.6 Updates

This menu page shows the current update settings for the device. By entering the menu new device software can directly be installed if available.

```

Config ▶
-----
Strategy ;General

```

```

Config settings
-----
●Apply settings
Inverters
Meters
EV Chargers
Auxiliaries

```

More information about the update settings can be found here: [Section 7.7](#)

5.1.7 System status

This menu page shows system status information. Internet connection, HUB setup and support information can directly be read from this page.

```

Config ▶
-----
Strategy ;General

```

```

Config settings
-----
●Apply settings
Inverters
Meters
EV Chargers
Auxiliaries

```

More information about the system status settings can be found here: [Section 7.6](#)

5.1.8 Inverters

If any inverters are configured, this menu page(s) show the current status for all inverter(s) combined. The AC power per inverter is also listed. Depending on the number of inverters configured, multiple pages are used.

```

Inverters
-----
Solar pwr : --kW
Solar yld : --kWh
INV RUN   : --
INV WARN  : --
INV ERROR : --

```

This menu page(s) displays the current status for each inverter. The displayed name of the inverter is the name of the group where it's in, combined with the inverter address. For

example the inverter "New 1.10" is a inverter from the inverter group "New 1" with the inverter address "10".

Inverters	
New 1.10	: --kW
New 1.11	: --kW
New 1.12	: --kW
New 1.13	: --kW
New 1.14	: --kW

Inverters	
New 1.15	: --kW
New 1.16	: --kW
New 1.17	: --kW
New 1.18	: --kW
New 1.19	: --kW

Inverters can be configured in the config settings for inverters explained on page: Section [6.3](#)

5.1.9 Meters

If any meters configured, this menu pages(s) displays the current grid power and current status for each meter. The displayed name of the meter is the name of the group where it's in, combined with the meter address. For example the meter "New 1.10" is a meter from the meter group "New 1" with the meter address "10".

Meters	
New 1.10	: --kW
New 1.11	: --kW
New 1.12	: --kW
New 1.13	: --kW
New 1.14	: --kW

Meters	
New 1.15	: --kW
New 1.16	: --kW
New 1.17	: --kW
New 1.18	: --kW
New 1.19	: --kW

Meters can be configured in the config settings for meters explained on page: Section [6.4](#)

5.1.10 P1 Smart meter

This menu page displays the P1 smart meter status. No metering values are shown here, only connection related information.

P1 smart meter	
CONN:	--
ERRS:	--
ID :	--
VERS:	--
CLTS:	--

P1 can be configured in the config settings for meters explained on page: Section [6.4.2.1](#)

5.1.11 Modbus

This menu page displays the current Modbus status for all the RTU and TCP ports. The individual RTU ports can be configured through this menu.

Modbus	
RTU A	: --
RTU B	: --
RTU C	:Idle
TCP	:Idle

More information about the Modbus settings can be found here: [Section 7.4](#)

5.1.12 Network ETH0

This menu displays the current ethernet status for the ETH0 connection.

Network ETH0	
IP	:192,168,1,77
NET	:255,255,240,0
GW	:192,168,0,1
DNS	:192,168,0,1
TYP	:DHCP

Network ETH0	
IP	:
NET	:
GW	:
DNS	:
TYP	:no link

More information about the ETH0 settings can be found on page: [Section 7.1](#)

5.1.13 Network ETH1

This menu displays the current ethernet status for the ETH1 connection.

Network ETH1	
IP	:192,168,1,196
NET	:255,255,240,0
GW	:192,168,0,1
DNS	:192,168,0,1
TYP	:DHCP

Network ETH1	
IP	:
NET	:
GW	:
DNS	:
TYP	:no link

More information about the ETH1 settings can be found on page: [Section 7.2](#)

5.1.14 Network Wi-Fi

This menu displays the current ethernet status for the Wi-Fi connection.

```

Network Wi-Fi ▶
-----
SSID: Embion B.V.
IP   : 192.168.1.194
NET  : 255.255.240.0
GW   : 192.168.0.1
TYP  : DHCP

```

```

Network Wi-Fi ▶
-----
SSID:
IP   :
NET  :
GW   :
TYP  : no link

```

More information about the Wi-Fi settings can be found on page: [Section 7.3](#)

5.1.15 GPIO

This menu page displays the GPIO status.

```

GPIO ▶
-----
GPI 1   : high
GPI 2   : low

```

```

GPIO settings
-----
● Invert GPI
  Control GPO

```

More information about the GPIO settings can be found on page: [Section 7.5](#)

5.2 Input description

On the COMCAM Stuurbox there are multiple inputs required like IP addresses, IP address ranges and names. The steps below will explain how to use the buttons to insert characters.

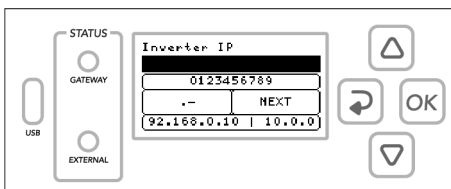

5.2.1 Input options

Use the buttons on the COMCAM Stuurbox to select one of the four input options related to the position of the pressed button.

For example: the UP button selects and highlight the numeric input.

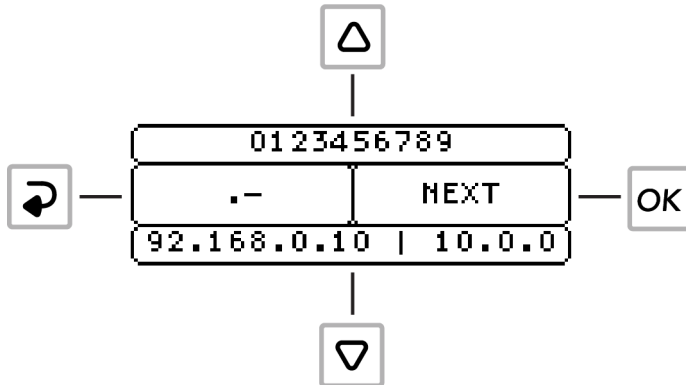

5.2.2 Select characters

When an input option is selected, use the UP and DOWN buttons to navigate and select a character or pre-defined value like and IP-address. Press the OK button or wait 3 seconds to confirm the selected character or value. Characters now appear in the input field as shown below.

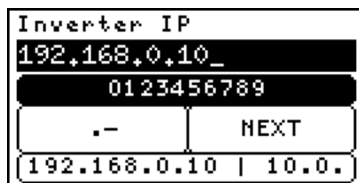

5.2.3 Remove characters

While one of the input option is selected, press the BACK button to remove the last character or hold the OK button to clear all input.

5.2.4 Uppercase

It is possible to use uppercase characters. Hold the UP button to activate uppercase characters, and hold it again to switch back.



6 Configuration settings

On the "Config settings" page the basic system settings are done. The following configuration item are found:

- Apply settings
- Inverters
- Meters
- EV Chargers
- Auxiliaries
- Grid settings
- Grid voltage control
- Active power control
- Arc detection
- GPIO control

Config settings
●Apply settings
Inverters
Meters
EV Chargers
Auxiliaries

6.1 Apply settings

All settings in the config menu can be changed without directly effecting the current function of the COMCAM Stuurbox. When settings are changed, the changes must be applied using this menu. Applying the settings can be done selecting one of multiple strategies. Each strategy has predefined controllers and certain required settings to be set. After applying a new strategy the system will check all requirements and only if all requirements for the strategy are met, the new strategy is applied.

Config settings
●Apply settings
Inverters
Meters
EV Chargers
Auxiliaries

6.2 Activate config

This configuration will activate all settings for a selected strategy. Changed settings are stored, but not applied until the wanted strategy is selected and correctly applied. If a faulty configuration is found, the selected strategy returns an error, and the system function is not changed. Only if the selected strategy is correctly configured, the new configuration is applied and the old configured strategy is replaced by the new one.

6.2.1 Select strategy

To activate all settings, a strategy needs to be selected. The current implemented strategies are:

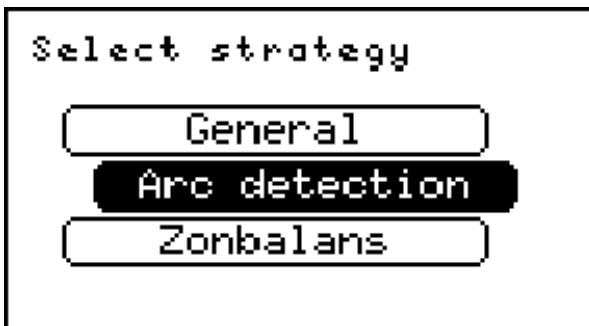

6.2.1.1 Zonbalans

Zonbalans will provide the stand-alone strategy using a grid meter, inverters and a pyrano sensor.

The maximum configured grid return power is used as maximum power. Until a measured radiation of $650 \frac{W}{m^2}$ the export limit is the configured grid return power. Between a measured radiation of $650 \frac{W}{m^2}$ and $975 \frac{W}{m^2}$ the export limit is linearly reduced from the configured grid return power to 0 kW. Therefore, at a measured radiation of $\geq 975 \frac{W}{m^2}$ the export limit is 0 kW.

During the activation of the Zonbalans strategy, the total installed inverter power is requested. This is the sum of the AC output power of all connected inverters. This value is used for correct control of the power. For correct functioning of the Zonbalans strategy, please make sure the inverter power is correctly entered.

When activating the Zonbalans strategy all other control functions, like controlling GPIO, EV-chargers, battery converters etc. will be disabled.

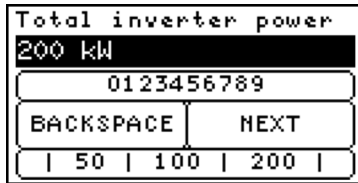

The COMCAM Stuurbox is able to check the validity of the measured solar radiation, using the actual measured solar radiation and the actual solar power, combining both values using the total PV power configured in the inverter groups. When the generated solar power becomes larger than could be possible with the actual radiation and configured PV power, an error is triggered and the export limit is fixed to 0kW. The error can be recovered in the Zonbalans menu.

When the error is triggered it could indicate a dirty or not correctly functional radiation sensor and therefore wrong Zonbalans limits. If needed the check can be disabled while the Zonbalans strategy is applied.

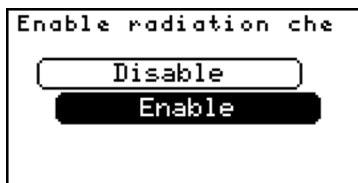

6.2.1.2 Arc detection

Arc detection will only provide the arc detection functionality using an external arc detection. This strategy will not implement any export or import limiter. This allows for easy and fast arc detection integration in existing systems.

6.2.1.3 General

General will provide all required controllers, except for the countering controller. This strategy uses the entered solar power per group and grid export limits to create (if required) an export controller. At least one grid meter is required to do so.

6.3 Inverter configuration

This configuration allows the user to configure the connected inverters (if any). multiple groups can be made, where each group connects to the same type of meters, through the same physical interface.

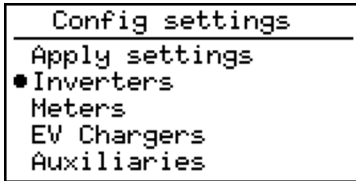

6.3.1 Inverter groups

The “Inverter groups” page will show all existing inverter groups. There is one pre-set group called “New 1” that isn’t configured yet, this group is automatically added by removing your last existing group.

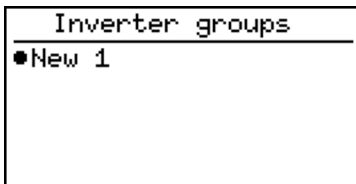

It is possible to add more groups, rename the existing groups, duplicate a specific group or delete one group. Select a group and hold the OK button to trigger this options.



i Note

To add more than 15 inverters, a licence is needed, inverter ranges in different groups will be counted together as single inverters.

6.3.2 Configure inverter group

The following inputs are required to configure a group of inverter(s):

- Inverter connection
- Address range
- Inverter type
- Inverter IP address
- Inverter TCP port
- Strings per inverter
- Total number of solar panels
- Peak power per panel

When the inverter has battery support, the following extra fields are required:

- Battery energy capacity (Capacity of battery, should be the same for all batteries in the group), used for weighted SoC average.
- Maximum active battery power
- Set charge prio
- Set discharge prio
- Minimum SOC (State of Charge)
- Maximum SOC
- Minimum SoC for remote control
- Maximum SoC for non-solar charge
- Allow automatic charge

i Note

Inverter IP and TCP port will only be asked when the selected connection type of the inverter is TCP/IP.

6.3.2.1 Inverter connection

Select the connection type of the to be configured inverter(s)

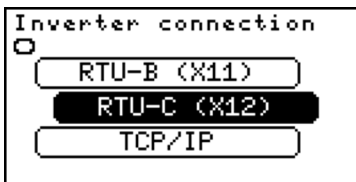

Inverter connection

RTU-B (X11)

RTU-C (X12)

TCP/IP

The following connection types can be selected:

- RTU-A (X10)
- RTU-B (X11)
- RTU-C (X12)
- TCP/IP

6.3.2.2 Inverter slave addresses

Insert the address range of the to be configured inverter(s). It is possible to separate addresses with the use of "," or to define a range with the use of "-". For example: The input "1,2,4-10" will set a address range from 1 to 10 except 3.

address range			
1,2,4-10			
0123456789			
-,		NEXT	
1-2	1-3	1-4	1,

i Note

An address may only occur once per RTU port. Meters and inverters could be connected to the same RTU port, as long as baudrate settings are identical and each connected slave has a unique address.

6.3.2.3 Inverter type

Select here the type or brand of the to be configured inverter.

Inverter type	
OO	
	Growatt-V2
	Goodwe
	Huawei V2
OOOOOO	

The following types can be selected:

- ABB PVS
- ABB Trio
- Afore HV
- Afore LV
- Altilia
- Autarco
- Boltainer
- Cellpower
- Chint
- Cubenergy PowerCombo
- Delta Sunspec
- Deye HV (Battery converter, no PV control)

- eCactus TH Hybrid (No solar control)
- Eaton Xstorage (no control function at the moment)
- Ferroamp
- FOX-ESS GMax
- Fronius (through datamanager (float32))
- GoodWe
- GoodWe-HT
- GoodWe Hyb
- GoodWe-MT
- Growatt-V1
- Growatt-V2
- Huawei Hybrid
- Huawei SL BESS
- Huawei V2
- Huawei V3
- INVT
- Maxus
- Megarevo
- OX Energy B-OX XL
- Pixii
- SAJ Plus series
- Sigenergy (no PV control, no total PV yield)
- SMA datalogger (only combined PAC, Yield and power control)
- SMA Sunspec
- SMA tripower
- SolaX 3phase
- SolaX Trene
- SolaX X3 Ultra Hybrid
- SolarEdge
- Sofar G1
- Sofar G2
- Sofar G3
- Sofar G3 Hyb
- Sofar Power Magic
- Solis
- Solis Hyb
- Sungrow
- Studer Next3
- Victron BESS (using Cerbo GX via TCP)
- Weiheng
- Zerversolar

6.3.2.4 Inverter IP

Insert the IP address of the to be configured inverter(s). For example: "192.168.0.125".

It is possible to define multiple addresses in the address range and only one IP address if all addresses can be reached through the same TCP/IP slave.

When the slaves are all reachable at the same address but on different IPs, it is possible to enter only one address and a range of IP addresses.

If each address has its own TCP/IP slave and a dedicated IP address, an IP range can be entered. To enter a range, the first IP address is entered followed by a ',' or a '-' and the last octet of the last IP address.

For example, if the address range is set to 1-4 (or 1, 2, 3, 4) and each address has a dedicated IP address, the IP input could be 192.168.0.10-13 (or 192.168.0.10, 11, 12, 13). The COMCAM Stuurbox will then translate this into the following IP addresses: 192.168.0.10, 192.168.0.11, 192.168.0.12, and 192.168.0.13.

i Note

It should be noted that when multiple IP addresses are defined, the number of defined addresses must be one or be equal to the number of defined IP addresses. Failure to meet this criteria will result in an error when the settings are applied.

Inverter IP	
192.168.0.125	
0123456789	
.	NEXT
192.168.0.10 10.0.	

i Note

Inverter IP will only be asked when the inverter connection type is TCP/IP.

6.3.2.5 Inverter TCP port

Insert the TCP port of the to be configured inverter(s). For example: "502"

Inverter TCP port	
0123456789	
BACKSPACE	NEXT
502	

i Note

Inverter port will only be asked when the inverter connection type is TCP/IP.

6.3.2.6 Strings/MPPT per inverter

Insert the number of individual string or MPPT data which should be read for every inverter connected to the group. Basically the number of individually monitored strings or MPPTs per inverter is entered here.

Strings per inverter				
4				
0123456789				
BACKSPACE		NEXT		
1	2	4	6	10

6.3.2.7 Installed solar panels

Enter the total number of solar panels installed for this group of inverter(s).

Total number of panel:				
32				
0123456789				
BACKSPACE		NEXT		
10	50	100	500'	

6.3.2.8 Peak power per panel

Enter the peak power per panel for the installed solar panels. The total solar power (Installed solar panels * Peak power per panel) is used to calculate the required export limit controllers. If different panels are used, make sure the total entered power (Installed solar panels * Peak power per panel) is correct.

Peak power per panel				
200 Wp				
0123456789				
BACKSPACE		NEXT		
200	300	400	45	

6.3.2.9 Enable active power control

If this setting is disabled the inverter is not controlled on active power. If needed some inverter groups can be excluded from the power control, while other groups have the control enabled.

⚠ Warning

The system controlled by the COMCAM Stuurbox should accept the control signal. To make this work, the external logger should be configured correctly. Active power control from the external logger should be disabled and the logger should accept external power control commands.

6.3.2.10 Maximum active battery power

This setting is only shown when a inverter with battery support is selected. The maximum active power of the battery can be entered. The COMCAM Stuurbox will limit the battery power setpoint to the configured value. The charge and discharge setpoints send to the battery will not exceed this value. The limit is applied per controlled battery. If multiple batteries are controlled per group, the limit is given per battery.

6.3.2.11 Battery energy capacity

The capacity of each battery. This capacity is used for the weighed SoC calculation. If multiple batteries are controlled within one group, the value is given per battery.

6.3.2.12 Set charge prio

Set the charge priority of the battery. When the priority is given free and the battery is allowed to charge, a charge setpoint is given to the battery. The charge priority should be lower (higher number) than the discharge priority.

6.3.2.13 Set discharge prio

Set the discharge priority of the battery. When the priority is not free yet, the discharge power will be maximum. Therefore the discharge can be used as peak shaving option to prevent exceeding the grid limits. The discharge prio should be higher (lower number) than the charge priority.

6.3.2.14 Minimum SoC

Set the minimum allowed SoC (State of Charge). When the SoC is reached the battery power setpoint will not allow any further discharge. If a SoC lower than the minimum SoC is measured, the battery is automatically charged with the configured charge prio, until the minimum SoC is reached.

6.3.2.15 Maximum SoC

Set the maximum allowed SoC (State of Charge). When the SoC is reached the battery power setpoint will not allow any further charge.

6.3.2.16 Minimum SoC for remote control

Minimum SoC to which the battery can be discharged via remote control. This value should be equal to or higher than "Minimum SoC". The difference is only used to compensate the grid import limit using the battery. When control generation is set to max via the public API or HUB the battery will discharge until this SoC is reached. When the battery is discharged due to grid limits which are remotely set (via public API or HUB), the discharge is not limited to this SoC.

6.3.2.17 Maximum SoC for non-solar charge

Maximum SoC for all charge actions, except negative grid power charge. The value should be equal or lower than "Maximum SoC", the difference can only be charged when "Charge with negative grid power" is enabled and the grid power becomes negative.

6.3.2.18 Allow automatic charge

When this setting is enabled, the battery will be given a charge setpoint as soon as the priority allows it. When it is disabled, the COMCAM Stuurbox will not automatically charge the battery, only if the consumption is set to maximum (or Charge battery with grid return power is enabled).

6.4 Meter configuration

This configuration allows the user to configure the connected meters (if any). multiple groups can be made, where each group connects to the same type of meters, through the same physical interface.

Note

Make sure the meter active power orientation is in the right convention used within the COMCAM Stuurbox.

A positive active power is always interpreted as a consumed power, while a negative active power is interpreted as a returned power.

Warning

When peakshaving for PV generation is active, the active power orientation for the grid meter should be correct. The COMCAM Stuurbox is only limiting (on grid power or grid current) the connected inverters when the measured grid power is negative (returning power to the grid).

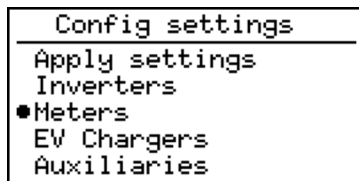

6.4.1 Meter groups

The "Meter groups" page will show all existing meter groups. There is one pre-set group called "New 1" that isn't configured yet, this group is automatically added by removing your last existing group.

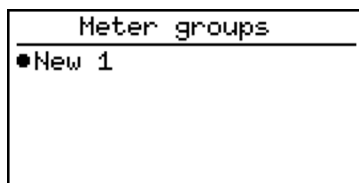

It is possible to add more groups, rename the existing groups, duplicate a specific group or delete one group. Select a group and hold the OK button to trigger this options.



i Note

To add more than 15 meters, a license is needed, meter ranges in different groups will be counted together as single meters.

6.4.2 Configure meter group

The following inputs are required to configure a group of meter(s).

- Meter connection
- Address range
- Meter type
- Meter location
- Meter IP address
- Meter TCP port

i Note

Address range will only be asked when the selected connection type of the meter(s) is RTU or TCP/IP.

i Note

Meter IP address and TCP port will only be asked when the selected connection type of the meter(s) is TCP/IP.

6.4.2.1 Meter connection

Select the connection type of the to be configured meter(s) the options are:

- RTU-A (X10)
- RTU-B (X11)
- RTU-C (X12)
- P1
- TCP/IP

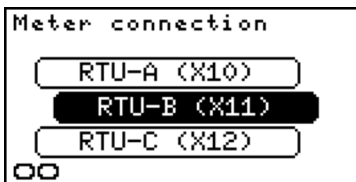

i Note

When meter(s) connection is P1, the only extra setting needed to complete are extra connected P1 meters and meter location.

6.4.2.2 Meter slave addresses

Insert the address range of the to be configured meter(s). It is possible to separate addresses with the use of "," or to define a range with the use of "-". For example: The input "1,2,4-10" will set a address range from 1 to 10 except 3.

Address range			
1,2,4-10			
0123456789			
-,	NEXT		
2	1-3	1-4	1,2,

i Note

An address may only occur once per RTU port. Meters and inverters could be connected to the same RTU port, as long as baudrate settings are identical and each connected slave has a unique address.

6.4.2.3 Meter type

Select here the type or brand of the to be configured meter. The following type or brands are available to select:

- ABB B23/B24 (No THD measurement)
- ABB M4M
- Anexo (Modbus converter)
- CarloGavazzi 1 phase (No THD measurement)
- CarloGavazzi 3 phase (No THD measurement)
- Chint DTSU666
- Chint DTSU666 (no series)
- Eastron
- Hager
- Huawei SL meter (energy meter connected to Huawei smartlogger) (No THD measurement)
- IME Conto (No THD measurement)
- IME Nemo
- IME Nemo EC
- Inepro PRO380 (NO THD and line-line voltage measurement)
- Janitza
- Mbus gateway
- Phoenix EEM series
- Schneider IEM 1 phase (No THD measurement)

- Schneider IEM 3 phase
- Schneider NSX
- Schneider PM5000 series
- Schneider PM8000 series
- Siemens PAC1600 7KT (No THD measurement)
- Siemens PAC2200 7KM (No THD measurement)
- Socomec Countis (No THD measurement)
- Socomec Diris A10
- Socomec Diris B10
- Weidemuller EM610

```
Meter type
  Eastron
  Socomec Diris
  Janitza
ooo
```

6.4.2.4 Meter IP

Insert the IP address of the to be configured meter(s). For example: "192.168.0.125".

It is possible to define multiple addresses in the address range and only one IP address if all addresses can be reached through the same TCP/IP slave.

When the slaves are all reachable at the same address but on different IPs, it is possible to enter only one address and a range of IP addresses.

If each address has its own TCP/IP slave and a dedicated IP address, an IP range can be entered. To enter a range, the first IP address is entered followed by a ',' or a '-' and the last octet of the last IP address.

For example, if the address range is set to 1-4 (or 1, 2, 3, 4) and each address has a dedicated IP address, the IP input could be 192.168.0.10-13 (or 192.168.0.10, 11, 12, 13). The COMCAM Stuurbox will then translate this into the following IP addresses: 192.168.0.10, 192.168.0.11, 192.168.0.12, and 192.168.0.13.

i Note

It should be noted that when multiple IP addresses are defined, the number of defined addresses must be one or be equal to the number of defined IP addresses. Failure to meet this criteria will result in an error when the settings are applied.

Meter IP	
192.168.0.125	
0123456789	
.	NEXT
192.168.0.10 10.0.	

i Note

Meter(s) IP will only be asked when the meter(s) connection type is TCP/IP.

6.4.2.5 Meter TCP port

Insert the port of the to be configured meter(s). For example: "502"

Meter TCP port	
0123456789	
BACKSPACE	NEXT
502	

i Note

Meter(s) port will only be asked when the meter(s) connection type is TCP/IP.

6.4.2.6 Meter location

Select here the meter(s) location of the to be configures meter(s), options are:

- Grid meter
- Load meter
- Solar meter
- MLOEA-PAP
- MLOEA-SAP
- MLOEA-TAP

i Note

The Grid meter is used for control. To make sure the readout speed is not limited it is good practice to connect the Grid meter to a un-used port (RTU-A, RTU-B, RTU-C), and connect other devices to other ports. On this way the maximum readout speed is reached.

i Note

The Solar meter can be used to measure power and energy flows from solar inverters which can not be connected directly. The measurement direction should be the same as for consuming loads. Therefore the measured active power should be negative when there is generation from PV.

i Note

For a MLOEA grid connection, all meters (MLOEA-PAP, MLOEA-SAP and optionally the MLEOA-TAP) need to be configured. The COMCAM Stuurbox will calculate the actual grid power and currents by combining all meters. The MLOEA meters will replace the grid meter, configuring both will result in an incorrect configuration. Setting up only one of the minimum of two MLOEA meters result in an incorrect configuration.

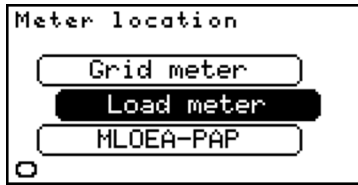

6.4.2.7 Split solar/grid

Available when load meter is selected. Enabling this function will create two new meter registers, one for the energy directly consumed out of Solar energy and one register for the energy directly consumed out of grid energy. Two possible system configurations are possible.

- System with at least one grid meter and 1 or more load meters. The system will count all energy sourced by the grid meter as grid energy, all energy consumed but not sourced by the grid meter is counted as solar energy.
- System without a grid meter, in this case the power delivered by the connected solar inverters is used to calculate the solar energy. All other energy is counted as grid energy.

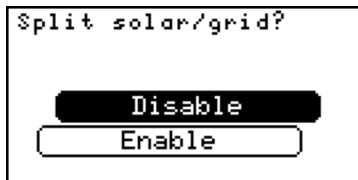

i Note

To activate the split solar/grid energy meters at least one grid meter or one solar inverter should be connected. An error is raised during setting activation when both (grid meter and solar inverter) are not configured.

6.4.2.8 Override scaling factor (only for P1 meter)

The values read from the P1 meter can be scaled with a fixed scaling factor. The default scaling factor is 1x. If "yes" is selected, the user will be prompted to enter the scale factor.

 Warning

Only change the default scaling factor if this is required by the grid operator. Selecting the wrong value will result in inaccurate energy measurement and improper control of active power!

6.4.2.9 Scale factor

This option is only available when "Override scaling factor" is set to "yes." Select the scale factor:

- 1x (default)
- 200x
- 500x
- 2000x

 Warning

Ensure to verify the scaling factor. Selecting the wrong value will result in inaccurate energy measurement and improper control of active power!

6.5 EV Chargers

This configuration will define all EV Charger(s) settings. (INTRO ABOUT EV CHARGERS)

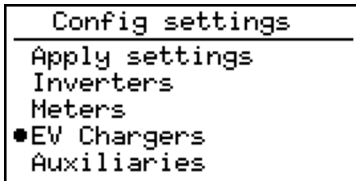

6.5.1 EV Charger groups

The 'EV Charger groups' page will show all existing EV Charger groups. There is one pre-set group called 'New group' that isn't configured yet, this group is automatically added by removing your last existing group.

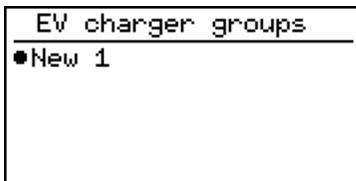

It is possible to add more groups, rename the existing groups, duplicate a specific group or delete one group. Select a group and hold the OK button to trigger this options.



i Note

To add more than 5 EV Chargers, a licence is needed. EV Charger ranges in different groups will be counted together as single EV Chargers.

i Note

When creating a group of EVChargers with type 'EVBox', only one group per RS485 port can be created.

i Note

When changing a group of EVChargers with type 'EVBox', the historical data of the EVBox chargers might become incorrect due to limitations of the EVBox protocol.

6.5.2 Configure EV Charger group

The following inputs are required to configure a group of EV Charger(s).

- EV Charger type
- EV Charger connection
- EV Charger slaves
- Min. charge current
- Max. charge current
- Set prio
- EV Charger IP

6.5.2.1 EV Charger type

Select here the type or brand of the to be configured EV Charger(s). The following type or brands are available to select:

- ABB Terra
- ABL eM4 Controller (socket 1) [ABL eM4 configuration](#)
- ABL eM4 Controller (socket 2) [ABL eM4 configuration](#)
- Alfen
- Alp-EV EVC04
- Amtron 4you TCP
- Amtron 4you RTU [Amtron 4you RTU configuration](#)
- Ctek (Firmware version r4.9 or newer)
- Etrek INCH
- EVBox G4
- Kempower DC charger (no total charged energy)
- Orbis
- Ratio
- Schneider EVLink Pro AC (Software version 1.2.1 and newer)
- Vestel EVC04

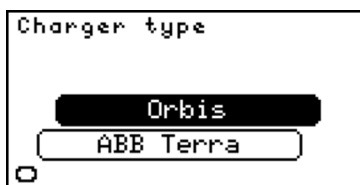

6.5.2.2 EV Charger connection

Select the connection type of the to be configured EV Charger(s) the options are:

- RTU-A (X10)
- RTU-B (X11)
- RTU-C (X12)
- TCP/IP

i Note

When 'EV Charger type' is set to 'EVBox', the connection type options "RTU" are renamed to "RS485" and TCP/IP is not available.

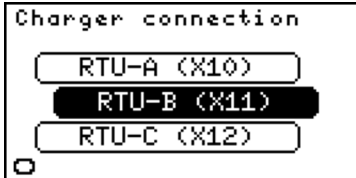

6.5.2.3 Amount of chargers

Enter the amount of EVBox chargers (both EVBox Hub and EVBox Satellite) connected to the the physical RS485 interface.

i Note

Amount of chargers will only be asked when the EV Charger(s) charger type is EVBox.

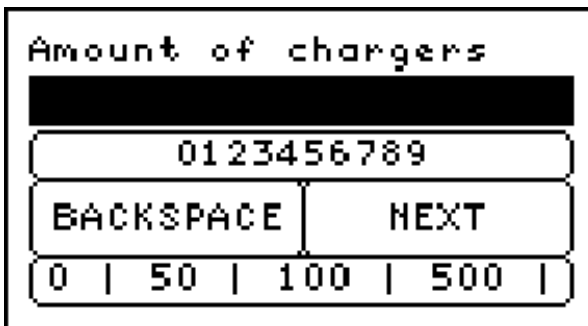

6.5.2.4 EV Charger slave addresses

Enter the slaves for the EV Charger(s). It is possible to separate slaves with the use of "," or to define a range with the use of "-". For example: The input "1,2,4-10" will set a the slaves 1 to 10 except 3.

i Note

EV Charger(s) slave addresses will only be asked when the EV Charger(s) connection type is RTU-A, RTU-B, RTU-C or TCP/IP.

Charger slaves			
1,2,4-10			
0123456789			
-,		NEXT	
1-2	1-3	1-4	1,

6.5.2.5 Min. charge current

Select the minimum charge current which is send to the device during import limitation. If the current is more than 0, the charger will not stop charging, even if the configured import limit is exceeded. The configured minimum charge current should be equal to or less than Max. charge current.

Min. charge current				
6 A				
0123456789				
BACKSPACE		NEXT		
6	10	16	20	2

6.5.2.6 Max. charge current

Select the maximum charge current which is send to the device when there is no import limit. The configured minimum charge current should be equal to or less than Max. charge current.

Max. charge current				
10 A				
0123456789				
BACKSPACE		NEXT		
6	10	16	20	2

6.5.2.7 Set prio

The priority for the EV charger current can be set. When power for consumption is available, the COMCAM Stuurbox will increase loads depending on their priority. A high priority (low number) is released first and reduced last. Therefore, an EV charger with priority 1 always

has the “Min. charge current” available, when the system limits allow it, the current is released to “Max. charge current”. Any other EV charger with priority 2 or higher has the “Min. charge current” available, and will only increase the current if system limits allow it, and all chargers with a lower priority number are fully released.

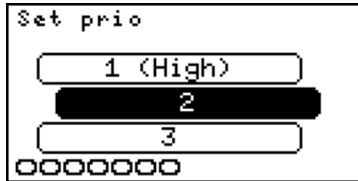

6.5.2.8 EV Charger IP

Insert the IP address of the to be configured EV Charger(s). For example: “192.168.0.125”.

It is possible to define multiple addresses in the address range and only one IP address if all addresses can be reached through the same TCP/IP slave.

When the slaves are all reachable at the same address but on different IPs, it is possible to enter only one address and a range of IP addresses.

If each address has its own TCP/IP slave and a dedicated IP address, an IP range can be entered. To enter a range, the first IP address is entered followed by a ‘,’ or a ‘-’ and the last octet of the last IP address.

For example, if the address range is set to 1-4 (or 1, 2, 3, 4) and each address has a dedicated IP address, the IP input could be 192.168.0.10-13 (or 192.168.0.10, 11, 12, 13). The COMCAM Stuurbox will then translate this into the following IP addresses: 192.168.0.10, 192.168.0.11, 192.168.0.12, and 192.168.0.13.

i Note

EV Charger(s) IP will only be asked when the EV Charger(s) connection type is TCP/IP.

i Note

It should be noted that when multiple IP addresses are defined, the number of defined addresses must be one or be equal to the number of defined IP addresses. Failure to meet this criteria will result in an error when the settings are applied.

EV IP	
192.168.0.125	
0123456789	
.-	NEXT
192.168.0.10 10.0.	

6.5.2.9 Charger IP port

Insert the port of the to be configured EV Charger(s). For example: "502"

Charger TCP port	
[REDACTED]	
0123456789	
BACKSPACE	NEXT
502	

i Note

EV Charger(s) port will only be asked when the EV Charger(s) connection type is TCP/IP.

6.6 Auxiliaries

This configuration will define all Auxiliaries settings. (INTRO)

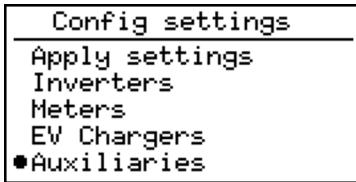

6.6.1 Auxiliaries groups

The 'Auxiliaries groups' page will show all existing Auxiliaries groups. There is one pre-set group called 'New group' that isn't configured yet, this group is automatically added by removing your last existing group.

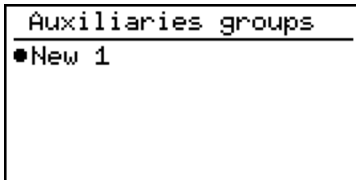

It is possible to add more groups, rename the existing groups, duplicate a specific group or delete one group. Select a group and hold the OK button to trigger this options.



i Note

To add more than 15 Auxiliaries, a licence is needed. Auxiliaries ranges in different groups will be counted together as single Auxiliaries.

6.6.2 configure Auxiliaries group

The following inputs are required to configure a group of Auxiliaries:

- Auxiliaries connection
- Auxiliaries slaves
- Auxiliaries type
- Auxiliaries IP

6.6.2.1 Auxiliaries connection

Select the connection type of the to be configured Auxiliaries the options are:

- RTU-A (X10)
- RTU-B (X11)
- RTU-C (X12)
- TCP/IP



6.6.2.2 Auxiliaries slave addresses

Enter the slaves for the Auxiliaries. It is possible to separate slaves with the use of "," or to define a range with the use of "-". For example: The input "1,2,4-10" will set a the slaves 1 to 10 except 3.

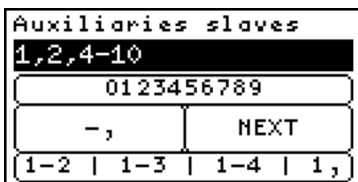

i Note

An address may only occur once per RTU port. Slaves of different types could be connected to the same RTU port, as long as baudrate settings are identical and each connected slave has a unique address.

6.6.2.3 Auxiliaries type

Select the connection type of the to be configured Auxiliaries the options are:

- Controllable load
- IO TM-P4A4 (Modbus GPIO module)
- Kipp&Zonen SMP3-A (Pyrano sensor)
- Huawei SL pyrano (Pyrano sensor connected to the Huawei smartlogger)

6.6.2.4 Controllable load

For the controllable load function a configured load meter with the same groupname is required. The COMCAM Stuurbox will use the power from the load meter with the same groupname as load power and will calculate the extra available power. This power setpoint is written to the configured controllable load device.

i Note

If a pyrano sensor connected to the Huawei smartlogger is configured, use the configured pyrano sensor address configured in the smartlogger.

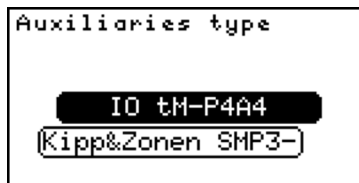

6.6.2.5 Auxiliaries IP

Insert the IP address of the to be configured Auxiliaries. For example: "192.168.0.125".

It is possible to define multiple addresses in the address range and only one IP address if all addresses can be reached through the same TCP/IP slave.

When the slaves are all reachable at the same address but on different IPs, it is possible to enter only one address and a range of IP addresses.

If each address has its own TCP/IP slave and a dedicated IP address, an IP range can be entered. To enter a range, the first IP address is entered followed by a ',' or a '-' and the last octet of the last IP address.

For example, if the address range is set to 1-4 (or 1, 2, 3, 4) and each address has a dedicated IP address, the IP input could be 192.168.0.10-13 (or 192.168.0.10, 11, 12, 13). The

COMCAM Stuurbox will then translate this into the following IP addresses: 192.168.0.10, 192.168.0.11, 192.168.0.12, and 192.168.0.13.

i Note

It should be noted that when multiple IP addresses are defined, the number of defined addresses must be one or be equal to the number of defined IP addresses. Failure to meet this criteria will result in an error when the settings are applied.

Auxiliaries IP	
192.168.0.125	
0123456789	
.-	NEXT
192.168.0.10 10.0.	

i Note

Auxiliaries IP will only be asked when the Auxiliaries connection type is TCP/IP.

6.6.2.6 Auxiliaries port

Insert the port of the to be configured Auxiliaries. For example: "502"

Auxiliaries TCP port	
0123456789	
BACKSPACE	NEXT
502	

i Note

Auxiliaries port will only be asked when the Auxiliaries connection type is TCP/IP.

6.7 Grid settings

In this configuration power and current limits for the plant can be defined.

6.7.1 Grid settings configuration

The following inputs are required to configure the grid settings:

- Grid current max
- Grid + power max
- Grid - power max

Config settings
Inverters
Meters
EV Chargers
Auxiliaries
● Grid settings

6.7.1.1 Grid current max

Enter the maximum allowed grid current for this plant. For example, the mains connection is 3x250 A, fill-in 250.

Grid current max
200 A
0123456789
BACKSPACE NEXT
80 160 250 400

Tip

This is typically the value of the main fuse.

6.7.1.2 Grid + power max

Enter the maximum active power which might be consumed from the grid. For example: 50 kW.

Grid + power max			
50 kW			
0123456789			
BACKSPACE		NEXT	
50	100	200	50

6.7.1.3 Grid - power max

Enter the maximum active power which might be exported to the grid. For example: 100 kW. The COMCAM Stuurbox will implement export limitation controllers for configured solar inverters if the configured solar power exceeds the configured limit.

Grid - power max			
100 kW			
0123456789			
BACKSPACE		NEXT	
50	100	200	50

6.8 Grid voltage control

The grid voltage control can be enabled to apply an active power controller in the COMCAM Stuurbox, regulating the measured grid voltage. The maximum line-neutral grid phase voltage is determined, if this voltage is larger than the configured maximum grid voltage, the inverter active power setpoint is reduced (Using a fixed PI controller). This will limit the active power and therefore lower the grid voltage.

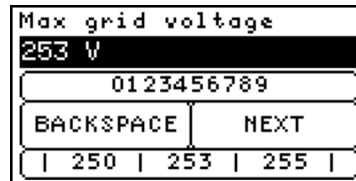
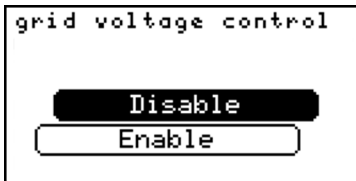

💡 Tip

The grid voltage measured by the inverter is likely to be higher than the voltage at the grid entrance or grid meter location. Hence, it is important to ensure that the maximum allowable grid voltage set in the inverter is higher than the configured maximum grid voltage in the COMCAM Stuurbox.

⚠ Warning

The P1 DSMR 4 protocol does not support phase voltage measurement. Therefore it is not possible to use grid voltage control when the grid meter is a P1 DSMR 4 energy meter.

6.9 Active power control

By default, the configured number and power of the solar panels, together with the configured maximum grid return power and maximum grid current let the COMCAM Stuurbox decide if an active power or current controller is required for the configuration. By default an plant control active power controller is also implemented. As user this default configuration can be altered, by changing the Active power control setting.

- Auto: (Default) depending on the configured limits an active power and/or current controller is implemented
- Force disable: all power controllers are disabled! Plant control, export limit control and grid voltage control is not possible. Be careful using this configuration!

- Force enable: enables the plant control, active power and grid current controller independent of the amount of solar power configured. Using this setting the maximum reduction value can be limited by the user.

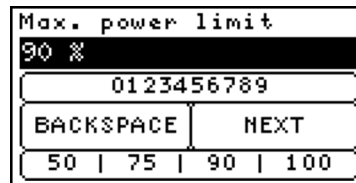
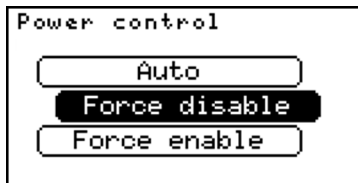

⚠ Warning

Setting the “Force disable” option will disable all active power controllers. There will be no grid current, power or voltage control done by the COMCAM Stuurbox. Also power control via plant control is disabled! Therefore inverters will not be limited when EPEX price control is active.

6.9.1 Safety margin

The “Safety margin” is 0 by default. It sets a positive offset to the configured grid return power. An example: a plant is not allowed to return power to the grid (negative grid power), so the maximum grid return power is set to 0. Due to loads which are switched off, some energy will still be returned to the grid. To prevent this, a safety margin can be configured. The COMCAM Stuurbox will offset the control setpoint with the safety margin. If the grid return power is set to 0kW and the safety margin is set to 5kW, the COMCAM Stuurbox will limit PV and battery power in such way the grid power is tried to be 5kW. When a load of 4kW is suddenly switched off, the grid power will still be positive and the COMCAM Stuurbox will correct for it.

⚠ Warning

Only utilize the safety margin option in instances where there is a highly stringent return-to-grid policy. Utilizing the safety margin will lead to an increase in total grid power consumption and consequently, costs.

6.9.2 Low power limit

The “low power limit” is disabled by default. This function can be enabled if the maximum generated solar power should be continuously controlled (even when the grid power or current is not close to the limit). This function prevents large peaks when solar power suddenly

increases but also increases the inverter ramp-up time. Enabling this option results in significantly lower peak powers. The total configured inverter power is required to correctly use this function. The function can't correctly operate when not all inverters are active, if one of the inverters is not active, the function will temporary be disabled.

 Tip

For systems with PV peak-shaving for a limited mains connection, it is advised to enable the low power limit option. This prevents high peak feeding currents which may trip the mains fuse.

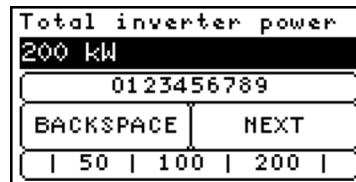
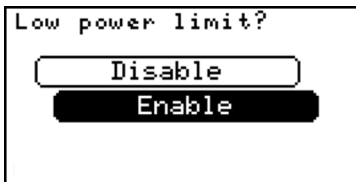

6.9.3 Total PV inverter power

(This value is only required when Low power limit is enabled). The sum of the total nominal PV inverter power. Inverter which are only used as battery converter should not be included in the sum.

6.9.4 Maximum power limit

Setting the maximum power limit to less than 100% will consistently restrict the inverters maximum output power to the configured percentage. Consequently, the maximum output power of the inverters will never be attained, even if the grid current and grid negative power have not yet reached their limits yet.

For Auto and Force enable the following options are available to configure low power limit:

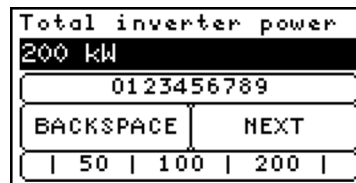
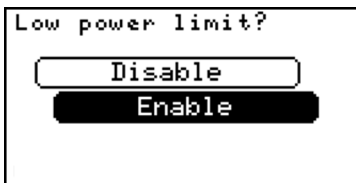

6.9.4.1 Allow PV for import limit

Default disabled. Enabling this function allows the PV limit controller to further increase PV power when the import limit is reached. Therefore the PV power could still be generated while the system is in MIN generation, only to prevent the import limit to be exceeded. PV is controlled with PRIO1, other priorities are processed first before PV power is increased.

6.9.4.2 Charge battery with grid return power

When this function is enabled, the battery charge power is increased when the mains active power becomes negative. Therefore the returned grid power could be used for charging the battery. It is advised to disable the "Allow automatic charge" option in the inverter group.

6.10 Arc detection

This configuration will define the external arc detection settings. By default external arc detection is disabled. Keep in mind, any GPIO used to connect to the external arc detection should be true when no arc is detected!

6.10.1 Arc detection configuration

The following inputs are required to complete Arc detection configuration:

- Input type
- Minimum PAC
- Inverter address

6.10.1.1 Input type

Select the input type for Arc detection, options are:

- Deactivate
- GPIO (use onboard GPIO for max 2 inverters)
- Ext. GPIO (use Modbus GPIO modules for multiple external arc detections)
- Both (Use as well the internal GPIO as external GPIO modules)

Select type of input

Use GPIO

Use Ext. GPIO

Use both

 Tip

The deactivate option will deactivate arc detection, even if the Arc detection strategy is selected. Arc detection is deactivated by default.

6.10.2 Minimum PAC

Enter the minimum PAC (Inverter AC power) required per inverter for an arc detection. If the AC power of the inverter is not at least as high as Minimum PAC, while a detection is done, the detection is neglected.

Minimum PAC for arc	
100 W	
0123456789	
BACKSPACE	NEXT
50 100 200 300	

6.10.3 Inverter address

This menu is only visible if the "Both" option is selected. It allows the user to select the one or two inverter addresses controlled by the internal GPIO. The other addresses will be logically (from low to high) mapped to the external GPIO modules. For example, if 5 inverters are configured, 1,2,3,4,5 and only 2 external GPIO modules are configured and "Inverter address" is set to 3,4: The first GPIO modules is connected to inverter 1, the second GPIO module to inverter 2 and GPI1 is connected to inverter 3, GPI2 to 4. Inverter 5 has no arc detection connected. Setting the "Inverter address" to 1 in this situation connects inverter 1 to GPI1 and inverter 2 to external GPIO 1 and inverter 3 to external GPIO 2.

inv addr for GPIO	
10	
0123456789	
-,	NEXT
1-2 1-3 1-4 1,	

6.10.3.1 Connecting the external arc detection

When connecting the external arc detection please check the following items:

- Make sure the arc detection is not latched on detection.
- Make sure the GPIO of the COMCAM Stuurbox or input on the external GPIO are HIGH when no detection is done and LOW when a detection is done.
- Check the functionality of the external arc detection
- Check the functionality of the configured COMCAM Stuurbox, check if the correct inverter is turned-off when a detection is done.

6.11 GPIO control

Allows the user to add multiple rules for the onboard or external GPIO. Actions can be triggered depending on the GPI (General Purpose Input) state or states can trigger GPO (General Purpose Output). The COMCAM Stuurbox has two GPI and two GPO onboard. It is possible to configure 4 independent GROUP states, which can be linked to the digital output of external IO modules.

Each rule added to the list can only handle one state, for example the following setting: "IN1 is HIGH then set Min gen set to TRUE" Will limit the generation when input1 becomes HIGH. After input1 becomes LOW again, no new action is triggered, so the system will stay in Min gen. To return to normal operation when input1 is low again, the following rule should also be added: "IN1 is LOW then set Min gen set to FALSE"

It is possible to use the following variables to define triggers:

- contr. gen. (Control Generation) which is the generation state which can be remotely set to MIN, NOM or MAX (default NOM)
- contr. cons. (Control Consumption) which is de consumption state which can be remotely set to MIN, NOM or MAX (default NOM)
- Psolar (System Solar power) which is the actual solar power (sum of solar power of all inverters), value is set in kW
- Pgrid (System grid power) which is the grid meter active power, value is set in kW
- Reduction which is the actual solar inverter limit value, 0 means solar is reduced to 0% of nominal, and 100 means solar is unlimited
- Battery SoC which is the (weighted) average of the connected battery SoC values, value is set in %
- Summed load meters which is the sum of the active power of all the load meters, value is set in kW
- Pbattery the total battery power in the system, value is set in kW
- PRIO the actual load prio 0-10, where 0 means all loads off and generate to reach the import limit, value is set between 0 and 10

As example, when GPO1 needs to be enabled when the grid power is -10kW and disabled when the grid power is 0kW the following rule can be set:

Group: GPO1 ON (give the action a logic name) Select GPIO: GPO1 (the rule will control GPO1) Set to: TRUE (The rule will enable GPO1) When: Pgrid (select grid power) Opperator: < (When greater than) Value: value (select free value input) Set value: -10 (set the value to -10kW)

Group: GPO1 OFF (give the action a logic name) Select GPIO: GPO1 (the rule will control GPO1) Set to: FALSE (The rule will enable GPO1) When: Pgrid (select grid power) Opperator: > (When greater than) Value: value (select free value input) Set value: 0 (set the value to 0kW)

As example, when GPO1 needs to be enabled when control generation is set to MIN remotely:

Group: GPO1 ON (give the action a logic name) Select GPIO: GPO1 (the rule will control GPO1) Set to: TRUE (The rule will enable GPO1) When: contr. gen (Select control generation as this value is changed remotely) Operator: == (Equal to) Value: min (MIN, to set GPO1 to true when contr. gen. is set to MIN)

Group: GPO1 OFF (give the action a logic name) Select GPIO: GPO1 (the rule will control GPO1) Set to: FALSE (The rule will disable GPO1) When: contr. gen (Select control generation as this value is changed remotely) Operator: != (Not equal to) Value: min (MIN, to set GPO1 to false when contr. gen. is NOT set to MIN)

 Tip

The activation and deactivation of a GPO or Group is always done in two separate actions. Multiple actions can be created which all enable or disable the GPO.

7 Device settings

This part of the manual will describe all device settings and configurations.

7.1 ETH0 settings

Shows the actual status of the ETH0 port, and allows user to change port IP configuration.

```
Network ETH0 ▶
IP :192.168.1.77
NET:255.255.240.0
GW :192.168.0.1
DNS:192.168.0.1
TYP:DHCP
```

7.1.1 ETH0 Setup

```
Network ETH0 setti
●ETH0 Setup
```

7.1.1.1 ETH0 Type

Select the type of ETH0 connection, options are:

- DHCP
- STATIC

```
Static / DHCP
  DHCP
  STATIC
```

i Note

When DHCP is selected as network type for ETH0, no other settings are needed for configuration. If Static is selected as ETH0 network type, other settings below are

needed.

7.1.1.2 ETH0 IP Address

Enter the IP address of the ETH0 network, for example: "192.168.0.10"

ETH0 IP address	
192,168,0,10	
0123456789	
.-	NEXT
192.168.0.10 10.0.	

7.1.1.3 ETH0 Gateway IP address

Enter the IP address of the network default gateway, for example: "192.168.0.1".

This field can be left empty when there is no default gateway for this connection (and therefore no internet connection through this port).

ETH0 Gateway address	
192,168,0,1	
0123456789	
.-	NEXT
192.168.0.10 10.0.	

7.1.1.4 ETH0 Netmask

Enter the network Netmask, for example: "255.255.255.0".

ETH0 Netmask	
255,255,255,0	
0123456789	
.	NEXT
255.255.255.0	

7.1.1.5 ETH0 DNS

Enter the DNS setting for ETH0, for example: "8.8.8.8".

This field can be left empty when there is no DNS required.

ETH0 DNS	
8.8.8.8	
0123456789	
.	NEXT
8.8.8.8	4.4.4.4

7.2 ETH1 settings

Shows the actual status of the ETH1 port, and allows user to change port IP configuration.

Network ETH0 ▶
IP :192.168.1.77
NET:255.255.240.0
GW :192.168.0.1
DNS:192.168.0.1
TYP:DHCP

7.2.1 ETH1 Setup

Network ETH1 setti
●ETH1 Setup

7.2.1.1 ETH1 Type

Select the type of ETH1 connection, options are:

- DHCP
- STATIC

Static / DHCP
<input checked="" type="radio"/> DHCP
<input type="radio"/> STATIC

i Note

When DHCP is selected as network type for ETH1, no other settings are needed for configuration. If Static is selected as ETH1 network type, other settings below are needed.

7.2.1.2 ETH1 IP Address

Enter the IP address of the ETH1 network, for example: "192.168.0.10"

ETH1 IP address	
192,168,0,10	
0123456789	
.	NEXT
192.168.0.10 10.0.	

7.2.1.3 ETH1 Gateway IP address

Enter the IP address of the network default gateway, for example: "192.168.0.1".

This field can be left empty when there is no default gateway for this connection (and therefore no internet connection through this port).

ETH1 Gateway address	
192,168,0,1	
0123456789	
.	NEXT
192.168.0.10 10.0.	

7.2.1.4 ETH1 Netmask

Enter the ETH1 Netmask, for example: "255.255.255.0".

ETH1 Netmask	
255,255,255,0	
0123456789	
.	NEXT
255.255.255.0	

7.2.1.5 ETH1 DNS

Enter the DNS setting for ETH0, for example: "8.8.8.8".

This field can be left empty when there is no DNS required.

ETH1 DNS	
8.8.8.8	
0123456789	
.	NEXT
8.8.8.8	4.4.4.4

7.3 Wi-Fi settings

Shows the actual status of the Wi-Fi connection, and allows user to configure Wi-Fi

Network Wi-Fi
SSID: Embion B.V.
IP : 192.168.1.194
NET : 255.255.240.0
GW : 192.168.0.1
TYP : DHCP

7.3.1 Wi-Fi Setup

Network Wi-Fi settin
● Wi-Fi Setup

7.3.1.1 Wi-Fi Enable

Enable or disable Wi-Fi

Enable Wi-Fi?
No
Yes

7.3.1.2 Wi-Fi Network

The device will ask to search for networks. A search will take a few seconds after which a network can be selected from a list.

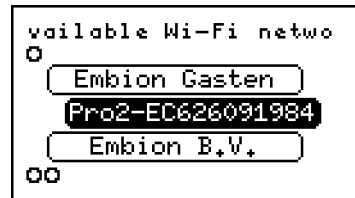
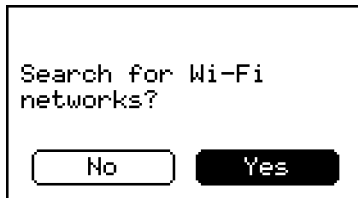

7.3.1.3 Wi-Fi Password

Enter the network password and apply the Wi-Fi settings.

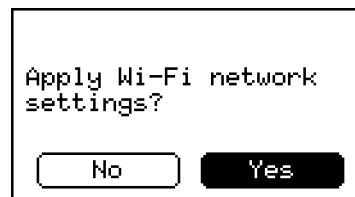
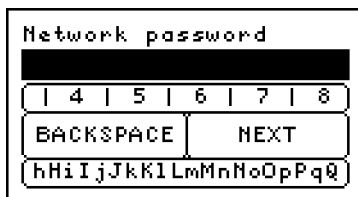

i Note

The device only supports the WPA2 security standard and uses DHCP for automatic configuration.

⚠ Note

For optimal use it is recommended to use the ethernet connection instead of Wi-Fi. Using Wi-Fi is dependent on the quality of the network and might result in stability and performance issues.

7.4 Modbus settings

This explains the RTU setup for:

- TCP
- RTU-A (X10)
- RTU-B (X11)
- RTU-C (X12)

```
Modbus settings
-----
●Setup TCP
Setup RTU-A (X10)
Setup RTU-B (X11)
Setup RTU-C (X12)
```

7.4.1 TCP configuration

7.4.1.1 Client / Server settings

To enable / disable Modbus TCP server on the COMCAM Stuurbox TCP, select the desired setting:

- Client (default)
- Client & Server

The Modbus client is used to communicate with the configured assets. The Modbus TCP server is used to readout or control to the COMCAM Stuurbox from an external controller with Modbus client support. Ask your sales representative for the actual Modbus register layout.

```
TCP Client / Server
Client (Default)
Client & Server
```

i Note

When 'Client & Server' is selected as setting, no other settings are needed for the Modbus TCP configuration. If 'Client' is selected, other settings below are needed.

7.4.1.2 Interface

Select to desired Modbus interface. For now, only one interface is available.

```
TCP Server interface
Version 1
```

7.4.1.3 TCP Port

Enter the TCP port for the Modbus Server TCP connection. The port is used to host the Modbus server on the ip address of the COMCAM Stuurbox. It is recommended to use port '502'.

TCP Server IP port (
502	
0123456789	
BACKSPACE	NEXT
50 100 500 100	

7.4.1.4 Unit ID

Enter the Modbus unit id for the Modbus Server TCP connection. The unit ID is used to identify the COMCAM Stuurbox in the Modbus network. Valid range is 1-247, as defined in the Modbus protocol.

TCP Server Modbus Un	
2	
0123456789	
BACKSPACE	NEXT
50 100 500	

7.4.2 RTU configuration

The following inputs are required to complete RTU configuration:

- Baudrate
- Parity
- Databits
- Stopbits

The default port configuration is 9600 8N1.

7.4.2.1 Baudrate

Select the baudrate for the RTU connector, options are:

- 9600
- 19200
- 38400

- 57600
- 115200
- 230400

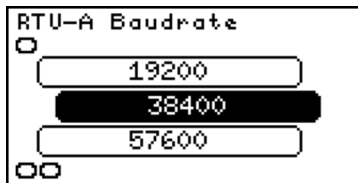

7.4.2.2 Parity

Select the parity for the RTU connector, options are:

- None
- Even
- Odd

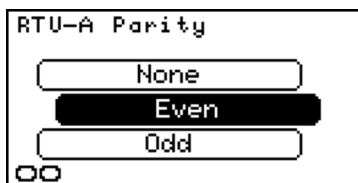

7.4.2.3 Databits

Select the databits for the RTU connector, options are:

- 8 bits
- 7 bits

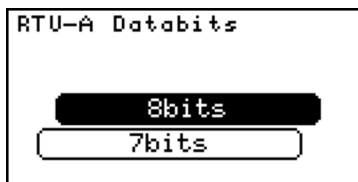

7.4.2.4 Stopbits

Select the stopbits for the RTU connector, options are:

- 1 bit

- 2 bits

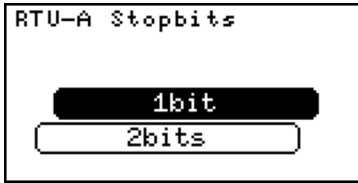

7.5 GPIO settings

The GPIO page shows the actual status of the input ports.

GPIO	
GPI 1	:high
GPI 2	:low

GPIO settings
●Control GPO

7.5.1 Control GPO

This menu allows the user to directly control the two output ports on the COMCAM Stuurbox.

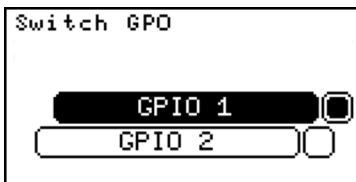

Warning

Forcing the GPO state can counteract the intended function!

7.6 System settings

This page shows actual connection status of the COMCAM Stuurbox.

- Internet, yes if the device was able to ping to an external ip.
- HUB, paired if the user has already paired the device to the HUB.
- Support, shows the support ID when support is enabled.

System settings contains

- Display setup (Dim brightness and Contrast settings)
- Language selection

```
System status ▶
Internet :Yes
HUB      :Not paired
Support  :7701aa9526
```

```
System status settin
●Display setup
  Language selection
  Help
```

7.6.1 Display setup (Dim brightness)

```
Dimm brightness
  Off
  Low
  Medium
OO
```

Select the low level of the backlight intensity. The COMCAM Stuurbox will reduce the backlight to the configured intensity when the buttons are not pressed for a while.

7.6.2 Display setup (Contrast settings)

```
Contrast setting
  Very low
  Low
  Medium
OO
```

Configures the display's contrast. By hovering over the options, the display contrast will change to the selected intensity.

7.6.3 Language selection

Configures the system language for all status and configuration pages.



7.6.4 Factory Reset

Performs a factory reset of the device. Be aware that this process will delete all user settings and configurations, returning the device to its original state. The device will ask for confirmation twice.

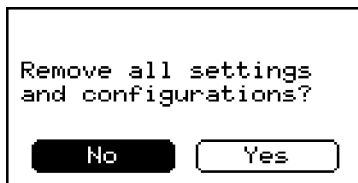

After confirmation, the device will reboot and reset. This will take less than a minute during which nothing is shown on the display and both status LEDs will be off. Once finished, you will be presented with the First Time Use wizard to set up the device again. Note that any license(s) will remain unaffected by the reset and will not be removed during this process.

7.7 Update settings

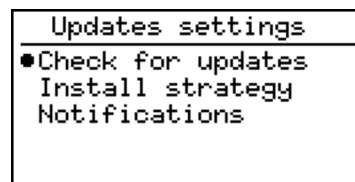
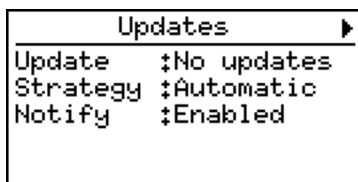

7.7.1 Check for updates

Manually verify if any software updates are available. The COMCAM Stuurbox should be connected to the internet to check for new updates.



7.7.2 Install strategy

Selects the strategy to run updates. Two options are available:

- **Automatically:** COMCAM Stuurbox will automatically download and install available updates at night.
- **Manual:** If enabled a notification is shown when an update is available. The device will not automatically install updates.

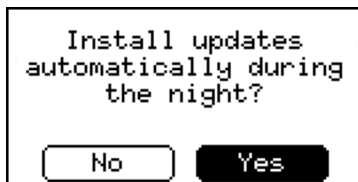

7.7.3 Notifications

Turn on or turn off update notifications on the COMCAM Stuurbox.



7.7.4 Channel

Select the active update channel.

- **Latest:** (default) get the latest official releases
- **Stable:** Only receive stable updates (version have already been tested for multiple weeks till months in a production environment)
- **Beta:** Receive Beta versions (no official release!)

⚠ Warning

The Beta channel is not recommended for devices in a production environment. Releases in the Beta channel are still in the testing phase. There is no warranty for the functionality of the software.

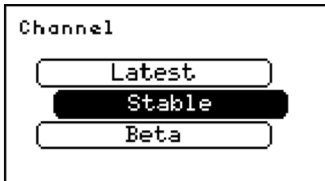

7.8 Plant control

This page shows the actual plant control status. When no plant control command is currently running the status is "idle" and all items contain "--". When a plant control command is remotely given the status becomes "active" and the given command is shown at the right item.

When a plant control command is active the external LED turns blue.

When no plant control is active the plant control page shows a idle status:

Plant control	
Status	:Idle
Import limit	:--kW
Export limit	:--kW
Consumption	:--
Generation	:--

Plant control	
TTL	:--s
Remaining	:--s

When plant control is active the plant control page shows active status with the current control value. In this example the control item is generation to min with a Valid time (TTL) of 300 seconds.

Plant control	
Status	:Active
Import limit	:--kW
Export limit	:--kW
Consumption	:--
Generation	:min

Plant control	
TTL	:300s
Remaining	:300s

8 Appendix

8.1 Device specific instructions

8.1.1 Amtron 4you RTU configuration

This chapter describes how to setup the Amtron 4you RTU EV charger models. Consult the respective installation manual for detailed instructions on how to install the Amtron charger.

Required settings on the COMCAM Stuurbox:

- RTU settings: 57600 baud, no parity, 2 stopbits, 8 databits
- Use device ID 50 (set by default at the Amtron RTU device)

Required settings on the Amtron 4you (300 series):

- On DIP switch Bank S1 set (at least) nr. 4 and 5 to ON position

8.1.2 ABL eM4 configuration

Consult the respective installation manual for detailed instructions on how to install the eM4 charger.

ABL eM4 Extender devices are currently not supported.

The software version of the eM4 Controller must be 2.2 or higher in order to be compatible with the COMCAM Stuurbox.

For the ABL eM4 Controller, both sockets are configured independent. The used address per socket is free to choose (must be unique per charger socket). For single sockets ev chargers use only socket 1.

8.1.3 EVBox

This chapter describe how to connect the RS485 cable to EVBox charging station models. Please consult the respective installation manual for detailed instructions on how to install the EVBox charger.

Warning

For information on how to install and / or commission the EVBox charger, please refer to the official documentation provided by EVBox.

8.1.3.1 EVBox G4

To connect the G4, install an RS485 cable from the COMCAM Stuurbox to the RS485 port on the G4 HUB(s). The G4 Satellites should be connected to the G4 HUB following the instructions provided by EVBox.

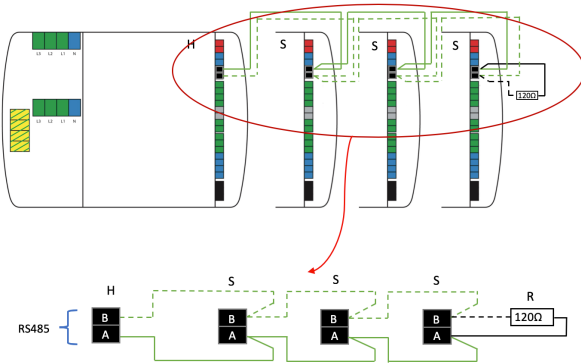

EVBox G4 master / slave setup. Source: EVBox manual

The RS485 cable should be connected to the RS485 port on each G4 HUB as shown in the figure below.

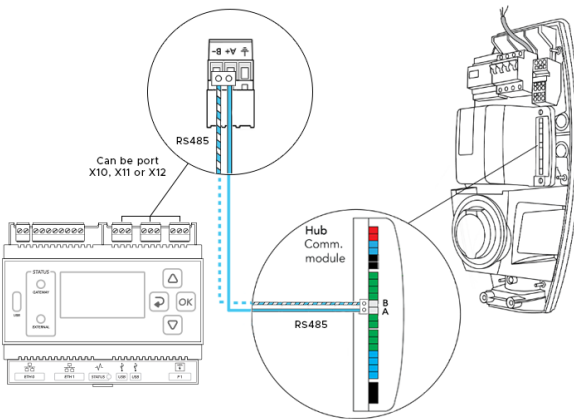

EVBox G4 RS485 connector



All products described in this document are owned by **Embion B.V.**

Address

Embion B.V.
Kalundborg 10
5026 SE, Tilburg

Contact

www.embion.eu
info@embion.nl

Copyright 2025 - Embion B.V.